



SAFEWAZE



FALL PROTECTION PRODUCT CATALOG

2026



Born in NC in 1994, Safewaze has become the #1 growing fall protection brand by pushing boundaries. As fall protection's most responsive partner, first – we listen. Then we deliver fast, flexible solutions tailored to your toughest jobs.

We continue to invest in manufacturing that matters. By advancing automation, driving innovation and staying committed to both our workers and yours, we are fulfilling our mission to protect lives and livelihoods at height.



Safewaze helps you really **understand** just how using safety equipment properly creates an even **safer workplace.**

Eugene Love
PPE User

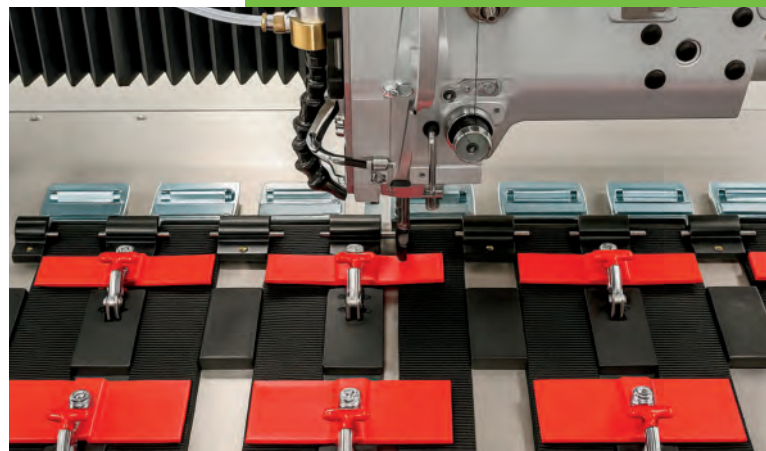



INDUSTRIES

We proudly serve America's trade professionals wherever they work at height.



AGRICULTURE



CONSTRUCTION



MINING



OIL & GAS



PLANTS & FACTORIES



SOLAR & WIND ENERGY



TOWER & UTILITIES



WAREHOUSES

For quick access to all of our technical information, visit our Technical Library online. Search easily by SKU or product name.



TEAM OF EXPERTS

When you need answers, we listen first. Then our team offers practical solutions and products that **will keep your team safe.** Just ask us!

TERRITORY MANAGERS

Jim Ciandella

Territory Manager,
Pacific Southwest
jciandella@safewaze.com

Chip Griffith

Territory Manager,
South-Central
cgriffith@safewaze.com

David Marks

Territory Manager,
Northeast
dmarks@safewaze.com

Chris Salisbury

Territory Manager,
Southwest
chris@safewaze.com

Phil Schaser

Territory Manager,
Midwest
phil@safewaze.com

Fred Silva

Territory Manager,
Latin America
fsilva@safewaze.com

Dane Williams

Territory Manager,
Mid-Atlantic/Carolinas
dwilliams@safewaze.com

Christian Zeagler

National Sales
Manager
czeagler@safewaze.com

CUSTOMER SUPPORT

Johana Benitez

Customer Service
Associate
johana@safewaze.com

Sabrina Courter

Customer Service
Associate
scourter@safewaze.com

Tyler Kyles

Technical Support
Specialist
tyler@safewaze.com

Katie McBride

Customer Service
Associate
kmcbride@safewaze.com

Trena Shutters

Sales Support
Manager
trena@safewaze.com

Amy Simpson

Sales Support
Associate
asimpson@safewaze.com

Frankie Smith

Customer Service
Associate
fsmith@safewaze.com

Melissa Smith

Customer Service
Supervisor
melissa@safewaze.com



Stephen Hartsell

President
stephen@safewaze.com

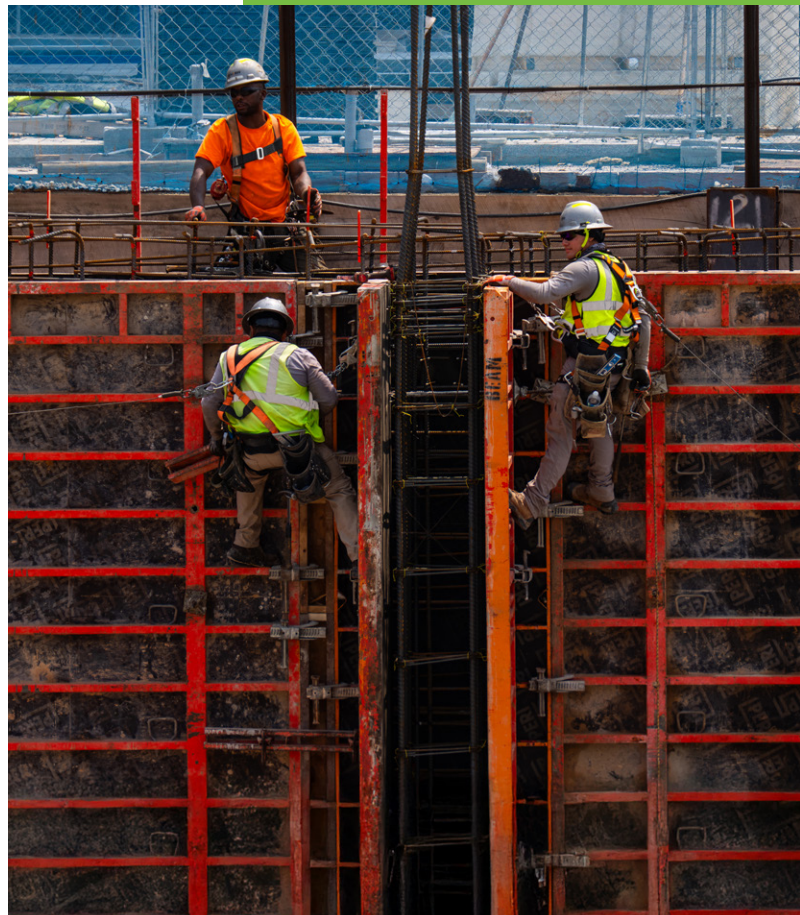



SAFEWAZE

TABLE OF CONTENTS

ANCHORS	06
HARNESSES	22
LANYARDS	54
SELF-RETRACTING LIFELINES	78
VERTICAL LIFELINES	108
HORIZONTAL LIFELINES	114
LADDER CLIMB SYSTEMS	126
CONFINED SPACE	134
XTIRPA	144
RESCUE	152
TOOL LANYARDS	160
KITS & COMBOS	164
ACCESSORIES	170

HEADQUARTERS

225 Wilshire Avenue SW
Concord, NC 28025

Purchase Orders:
orders@safewaze.com

Customer Service:
info@safewaze.com

Hours: **8AM - 5PM ET**
Monday to Friday



**INTERESTED IN THE NEWEST
RELEASES FOR ANCHORS?**
Scan this code to view them now!

ANCHORS

Anchors are the foundation of fall protection. These attachment points must sustain a fallen worker under the tremendous forces generated during a drop. From the mobile convenience of a strap anchor to the cast-in-place security of a concrete post anchor, Safewaze has the support you need.



ROOFING ANCHORS

Anchor point solutions for fall arrest systems on roofs. Used in maintenance work, repair and new construction jobs. Offered in both temporary and permanent designs.



CONCRETE ANCHORS

Anchor element cast in place or post-installed into hardened concrete which can be used to transmit loads to the concrete. Offered in both temporary and permanent designs.



STEEL ANCHORS

Fall protection anchor points designed to be attached to I-beams and other structural steel members. Offered in a wide variety of portable, bolted and welded solutions.

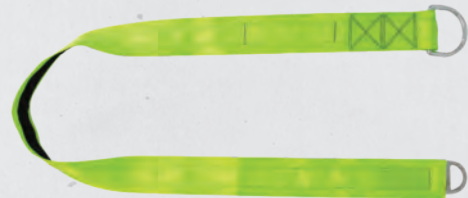

STRAP ANCHORS

A selection of non-penetrating lightweight anchor solutions that are easy to use, mobile and meet the needs of a wide variety of job site situations.



SPECIALTY ANCHORS

Specialized anchor points designed to offer unique solutions to various fall arrest applications.



022-4090 / MEMBRANE ANCHOR

- Easy drop-through installation (no access under roof required)
- Permanent, single point anchor for lanyards, SRLs and VLLs
- Elevated eye bolt (4") prevents abrasion from connecting hardware
- 360° working radius increases efficiency
- Accommodates roof thicknesses from 3" to 12"



019-4010 / 360° ROOF ANCHOR

- Temporary and reusable on wood roofs
- Easy installation with full 360° working radius
- Includes (6) 1/4" x 3" stainless lag screws



024-4112 / CORRUGATED ROOF ANCHOR: Steel

- Reusable on most corrugated roof types
- Use fasteners compatible with specific roof
- After removal, reinstall fasteners to maintain roof integrity
- 360° rotating swivel D-ring for max mobility

024-4113 / Corrugated Roof Anchor: Stainless Steel

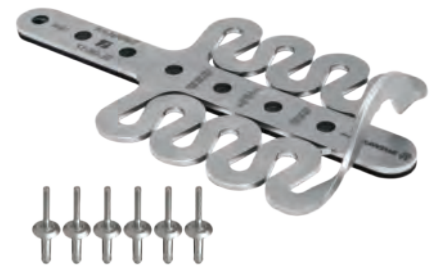

019-4006 / FROGLINK PERMANENT ROOF ANCHOR WITH RIVETS

- 360° working radius for use as single point anchor or with HLL
- Built-in energy absorber reduces stress and damage to mounting structure
- Durable stainless steel construction

019-4005 / FrogLink Temporary Roof Anchor

019-21001 / Hand Rivet Tool

020-16001 / Replacement Rivets



022-4092 / TILELINK ANCHOR (SCREWS)

- Installs under tiles - no cutting sarking for max weather protection
- Discreet low profile with only connection point exposed
- Temporary or permanent installation into wooden truss
- Built-in energy absorber reduces stress or damage to the mounting structure

022-4094 / TileLink Anchor (Rivets)



FS-EX310-1 / RING ANCHOR

- Compact, reusable anchor for wood roofs
- Easy installation
- Large connection ring

FS870 / REUSABLE ROOF ANCHOR

- Installed on peak or flat wood and metal decking roofs
- Hinged construction for adjustment to different angles
- Corrosion-resistant with large connection ring

FS870N / Reusable Roof Anchor, 20pc Nails

021-4065 / 20pc 16D Roofing Nails for FS870

FS870S / Reusable Roof Anchor, 12pc Sheet Metal Screws

021-4066 / (12) #10 2-1/2" Sheet Metal Screws for FS870



018-4000 / CHAIN ANCHOR

- Use on flat or sloped wood roofs
- O-ring connection as single point anchor or with HLL
- Durable steel chain, reinforced synthetic strap



021-4076 / 4-POINT PLATE ANCHOR

- Increased range with 4 steel loop connection points
- Versatile use as single point anchor or with HLL
- Easy to install, reusable and temporary
- For use on wood, steel and concrete



FS871 / KNOCK-DOWN ROOF ANCHOR

- Economical, disposable design
- For use on a wide variety of wood roof pitches
- Flexible steel for easy installation where needed

FS871-25 / Knock-Down Roof Anchor: Pack 25

FS871N / Knock-Down Roof Anchor, 8pc Nails

021-4067 / 8pc 16D Roofing Nails for FS871



021-4042 / WOOD TRUSS/ ATTIC ANCHOR

- Unique anchor solution for overhead use
- Lightweight, easy installation and removal
- Effective for new construction or existing attic space



020-4025 / PEAK ROOF ANCHOR

- Permanent use, easy installation on wood roof
- Dual D-ring for easy access to both sides of peak
- Low profile, minimalistic design with durable construction



020-4026 / PERMANENT ROOF ANCHOR

- Permanent use, easy installation between peak and eaves
- Low profile, minimalistic design with durable construction

020-4027 / Ridge Roof Anchor



022-4084 / SRL SWIVEL ROOF ANCHOR

- Installs on Z-purlin, metal decking, wood roof and flat concrete (3000 PSI)
- 360° swivel base accommodates most SRL sizes
- Quickly attach SRL to post, no disassembly required
- D-ring for EA lanyards, VLLs and HLLs
- Includes fasteners to install on wood or metal



FS-EX325 / 12" POST ANCHOR

- Fixed anchor for use as single point anchor or with HLL
- For use on wood, steel and concrete decks
- Corrosion-resistant galvanized coating

FS-EX326 / 18" Post Anchor



025-4126 / STANDING SEAM BAR ANCHOR: NYLON TIPPED SCREWS

- Easy to install, reusable, non-penetrating anchor point
- 360° swivel D-ring for SRLs, EA lanyards and VLLs
- For use on sloped or flat standing seam roofs

024-4115 / Standing Seam Bar Anchor: Steel Screws



023-4095 / STANDING SEAM SRL SWIVEL ANCHOR

- Easy to install, reusable, non-penetrating
- Adjustable crossarm spans 24"-40"
- 360° swivel base fits most SRL sizes
- Quickly attach SRL directly to post
- D-ring for EA lanyards, VLLs and HLLs
- Includes (6) S-5-U brackets



025-4129 / STANDING SEAM HLL ANCHOR

- Easy to install, reusable non-penetrating
- Designed for pitched or flat standing seam roofs
- Adjustable crossarm spans 24"-40"
- 360° swivel D-ring for SRL-Ps, EA lanyards, VLLs and HLLs



FS-EX311 / STANDING SEAM ROOF ANCHOR

- Easy to install, reusable non-penetrating anchor point
- Designed for sloped or flat standing seam roofs
- For use on a wide range of standing seams



023-4096 / STANDING SEAM SWIVEL ANCHOR

- Easy to install, reusable, non-penetrating
- Adjustable crossarm spans 24"-40"
- 360° swivel D-ring for SRL-Ps, EA lanyards and VLLs
- Includes (4) S-5-U brackets

025-4128 / STANDING SEAM STEEL SET SCREWS (SET OF 12)

- Use with 025-4126 and 025-4129

025-4127 / Standing Seam Nylon Tipped Set Screws
(Set of 12)

023-4101 / S-5-U CLAMP

- Use with 023-4096 and 023-4095



022-4085 / REMOVABLE CONCRETE ANCHOR

- Removable and reusable with reliable durability
- 360° rotating connection point for increased user mobility
- Easy trigger provides quick release for repeated use
- Durable cap for optional hammer assisted removal
- For horizontal, vertical and overhead use - including with HLLs



021-4054 / 5K SWIVEL ANCHOR & CONCRETE WEDGE BOLT

- 180°/360° rotating connection point for mobility
- Easily installed or removed
- Versatile vertical or horizontal use
- Heavy-duty expansion bolt



021-4052 / 5K SWIVEL ANCHOR & CONCRETE BOLT

- 180°/360° rotating connection point for mobility
- Easily installed or removed
- Versatile vertical or horizontal use



021-4081 / 5K SWIVEL D-RING ANCHOR ASSEMBLY

- Swivels with 180°/360° rotation
- Easily installed or removed
- Versatile vertical or horizontal use

021-4057 / 5K Replacement Concrete Wedge Bolt

021-4072 / 10K Swivel Anchor & Concrete Wedge Bolt

021-4073 / 10K Replacement Concrete Wedge Bolt

021-4053 / Replacement Concrete Bolt

021-4082 / 5K Swivel D-ring Anchor

021-4083 / 5K Swivel D-ring Anchor Bushing/Washer Set



024-4114 / D-PLATE ANCHOR

- For use on steel surfaces, I-beams or fully cured concrete (3000 PSI)
- For use as single point anchor with SRLs and lanyards
- Versatile use with VLLs, HLLs and material hauling
- Permanent, temporary, overhead or vertical use



020-4029 / 18" POST ANCHOR, CONCRETE

- Fixed anchor for use as single point anchor or with HLL
- Cast-in-place concrete installation
- Corrosion-resistant galvanized coating



FS880 / CONCRETE ANCHOR STRAP (4')

- Heavy duty webbing with wear sleeve
- D-ring connection point
- Reinforced loop slips over rebar for easy installation

FS880-1 / Concrete Anchor Strap

FS880-6 / Concrete Anchor Strap

FS880-8 / Concrete Anchor Strap

FS880-10 / Concrete Anchor Strap



70180 / CONCRETE ANCHOR STRAP : Soft Loop (4')

- Heavy duty webbing with wear sleeve
- Reinforced web loops at each end
- Loop attachment slips over rebar for easy installation overhead

70200 / Concrete Anchor Strap:
Soft Loop (6')

70280 / Concrete Anchor Strap:
Soft Loop (8')

70300 / Concrete Anchor Strap:
Soft Loop (10')

70380 / Concrete Anchor Strap:
Soft Loop (15')



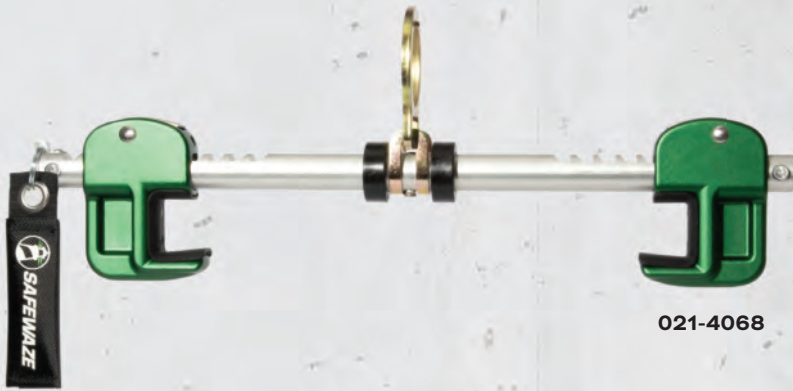

021-4068

021-4068 / BEAM WALKER EASY SLIDER 3.5"-14"

- 180° rotating connection, dual adjustment
- Lightweight aluminum, easy sliding nylon rollers
- Smooth trailing for hands-free work
- One-handed trigger for quick lock & release
- Overhead and foot level tie-off

021-4069 / Beam Walker Easy Slider 12"-30"



021-4069



Easy Trigger



018-4001 / BEAM TROLLEY ANCHOR

- Coated steel D-ring, lightweight aluminum
- For use on overhead horizontal I-beams
- Abrasion, heat and chemical resistant nylon wheels
- Ideal for use in steel, specialty and food processing



019-4009 / VERTICAL/STATIONARY BEAM ANCHOR

- Installs in seconds, simple to use
- Lightweight aluminum, rotating end connection
- For use in horizontal and vertical orientations



021-4075 / SLIDING BEAM ANCHOR 3.5"-14.5"

- 180° rotating connection, single adjustment
- Lightweight aluminum, easy sliding nylon rollers
- Smooth trailing for hands-free work
- One-handed trigger for quick lock & release
- Overhead and foot level tie-off

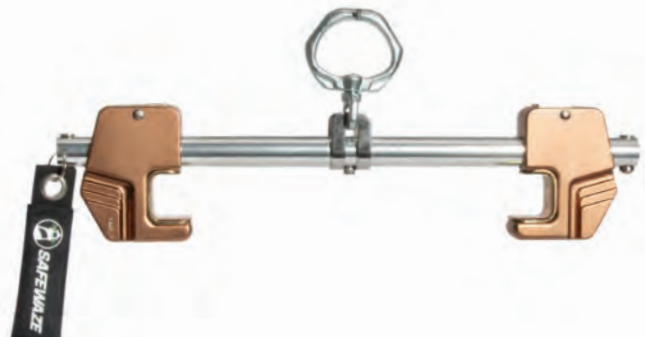

021-4055 / PREMIER SLIDING BEAM ANCHOR

- 180°/360° swivel connection, dual adjustment
- Lightweight aluminum, smooth trailing
- One-handed trigger for quick lock and release
- Overhead and foot level tie-off



FS887 / D-BOLT ANCHOR

- Fixed anchor for use as single point anchor or with HLL
- Easy to install, temporary or permanent use
- Fits rated structures 3" or less



FS888 / BOLT ON D-RING ANCHOR

- D-ring moves freely after installation
- Fixed anchor for use as single point anchor or with HLL
- Bolted or welded on, temporary or permanent use



023-4108 / TOGGLE ANCHOR

- Versatility in steel or hollow core concrete structures
- Easy installation and removal, no tools or fasteners required
- Built-in indicator wire ensures proper installation
- Multi-directional use with all PFAS and HLLs



019-4007 / GIRDER GRIP ANCHOR

- Economical, quick installation and removal
- Horizontal or vertical use in metal and steel



020-4030 / 18" POST ANCHOR - I-BEAM

- Temporary anchor for use as single point anchor or with HLL
- Bolt to or around steel I-beams up to 10"
- Corrosion-resistant galvanized coating



021-4048 / 10K SWIVEL STEEL ANCHOR & PUCK ASSEMBLY

- 180°/360° rotating connection point
- Built with heavy duty forged steel
- Easy temporary or permanent installation

021-4041 / 10K Steel Puck & Bolt

021-4040 / 10K Swivel Anchor Bolt

021-4044 / 10K Swivel Steel Anchor



021-4059 / 5K SWIVEL STEEL ANCHOR & PUCK ASSEMBLY

- 180°/360° rotating connection point
- Heavy-duty, corrosion-resistant
- Easy temporary or permanent installation

021-4064 / 5K Steel Puck & Bolt



021-4047 / 5K SWIVEL STEEL ANCHOR & BOLT

- 180°/360° rotating connection point
- Temporary or permanent, vertical or horizontal
- Quick, easy installation

021-4062 / 5K Swivel Steel Anchor

021-4070 / 5K Swivel Anchor Bolt



021-4046 / 5K SWIVEL STAINLESS STEEL ANCHOR & BOLT

- 180°/360° rotating connection point
- Temporary or permanent
- Vertical or horizontal use
- Quick, easy installation

021-4045 / 5K Swivel Stainless Steel Anchor

021-4063 / 5K Stainless Steel Puck & Bolt

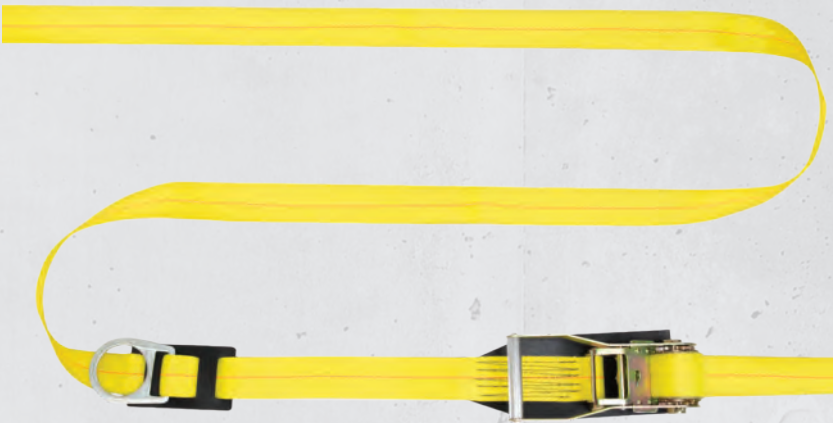

FS-EX400-15 / RATCHET ANCHOR STRAP

- Ratcheting tensioner for secure fit without slippage
- For use around columns, posts or other rated structures
- Lightweight and portable with easy installation

FS-EX400-30 / Ratchet Anchor Strap



FS810-3 / REINFORCED CROSS ARM STRAP

- Highly adaptable with heavyweight webbing
- Abrasion resistant sling webbing wear pad
- Lightweight and portable with easy installation

FS810-6 / Reinforced Cross Arm Strap

FS810-10 / Reinforced Cross Arm Strap

FS810-15 / Reinforced Cross Arm Strap

FS810-20 / Reinforced Cross Arm Strap



FS811-3 / CROSS ARM STRAP

- Convenient, reusable and mobile
- Durable strap webbing
- Lightweight and portable with easy installation

FS811-4 / Cross Arm Strap

FS811-6 / Cross Arm Strap

FS811-10 / Cross Arm Strap

FS811-15 / Cross Arm Strap

FS811-20 / Cross Arm Strap



**FS812 / ADJUSTABLE
CROSS ARM STRAP**

- Convenient, reusable and mobile
- Durable webbing adjusts from 4' to 6'
- Lightweight and portable with easy installation



**FS88811-HW / 6' HEAVY
DUTY CROSS ARM
STRAP**

- Highly adaptable with heavyweight webbing
- Lightweight and portable with easy installation

**FS88811-HW-10 / 10' Heavy Duty
Cross Arm Strap**



**024-4116 / 3' ARC FLASH
CHOKER ANCHOR**

- Lightweight, portable and reusable
- Simple choke-style installation
- Flame and heat resistant aramid webbing

**024-4117 / 6' Arc Flash
Choker Anchor**

**024-4118 / 12' Arc Flash
Choker Anchor**



**FS815 /
SCAFFOLD ANCHOR**

- Durable webbing, 18" length
- Easy cinch-style installation
- Lightweight, portable and reusable



**FS814 / 18"
ANCHOR: REBAR
HOOK, D-RING**

- Easy hook connection to rebar, pipe, beams
- 18" fixed length with convenient D-ring attachment



**025-4132 / 23"
WEB REBAR
HOOK ANCHOR**

- Large hook connection to rebar, pipe, beams
- 23" fixed length with convenient D-ring attachment



**025-4133 / 26"
CABLE REBAR
HOOK ANCHOR**

- Large hook connection to rebar, pipe, beams
- 26" fixed length with convenient O-ring attachment



FS830 / 2' CABLE ANCHOR

- Thimble captive eye connections on each end
- Cinch around structure with carabiner (not included)
- Lightweight and portable with easy installation

FS830-4 / 4' Cable Anchor

FS830-6 / 6' Cable Anchor

FS830-8 / 8' Cable Anchor



FS830-C3 / 3' CABLE CHOKER ANCHOR WITH O-RINGS

- Choke-style installation with pass-through O-rings
- Lightweight, portable and reusable

FS830-C6 / 6' Cable Choker Anchor w/ O-rings

FS830-C8 / 8' Cable Choker Anchor w/ O-rings

FS830-C10 / 10' Cable Choker Anchor w/ O-rings



FS830-C3-1 / 3' CABLE EXTENDER: Snap Hook

- Used to extend the length of existing choker anchor
- Lightweight and portable with easy installation

FS830-C6-1 / 6' Cable Extender: Snap Hook

FS830-C8-1 / 8' Cable Extender: Snap Hook

FS830-C10-1 / 10' Cable Extender: Snap Hook



FS830-C3-2 / 3' CABLE SLING ANCHOR: Snap Hook

- (2) O-rings for connection and anchor point
- Lightweight and portable
- Wrap-around installation

FS830-C6-2 / 6' Cable Sling Anchor: Snap Hook

FS830-C8-2 / 8' Cable Sling Anchor: Snap Hook

FS830-C10-2 / 10' Cable Sling Anchor: Snap Hook



PVC coated cable anchors provide long-lasting protection



024-4109 / REACH ANCHOR ASSEMBLY

- Proprietary system remotely anchors to I-beams, pipes and more
- Easy 2-step installation to attach anchor then raise PFAS
- Remote release plus safety toggle to prevent accidental disengagement
- Premium grade aluminum adds durability and strength
- Includes anchor, telescoping pole, dual pole head attachment and FS8175 carry bag

022-4086 / Reach Anchor

023-4107 / Reach Anchor Pole



025-4125 / REACH ANCHOR: Pole Head Attachment V2

- Dual function with release hook and magnet attachment
- Replacement for 022-4086 & 024-4109



022-4089 / STRUT ANCHOR

- Simple, one-handed installation
- Attached plates means no loose parts
- Red warning indicator ensures proper setup
- Smooth sliding action allows hands-free work
- Includes steel carabiner

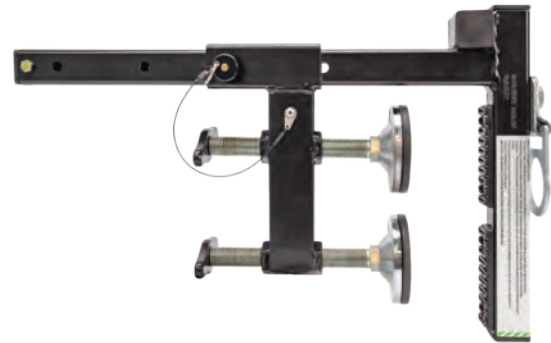

SW900 / PARAPET WALL ANCHOR: 14"

- Non-penetrating padded design eliminates wall damage
- (2) tightening handles for even force distribution
- Heavy-duty, versatile, portable and reusable

SW900-2 / Parapet Wall Anchor: 21.5"



SW901 / WINDOW DOOR JAMB ANCHOR

- Lightweight, portable and reusable
- Quick installation without damage to structure
- 59.5" long for jamb openings 23.2"-49.2"



020-4020 / 2' DROP-THROUGH CABLE ANCHOR

- Versatile and portable
- Simple to use
- High visibility green steel plate
- Durable cable with wear sleeve
- Ideal for use in steel grating

020-4021 / 8.5' Drop-Through Cable Anchor



023-4105 / SHUTTLE ANCHOR

- Semi-permanent overhead anchor solution for SRLs
- Quickly raise/lower SRLs for safe storage when not in use
- Compact, lightweight and highly durable for longevity
- Versatile installation to a variety of rated structures
- Includes anchor, cord, tagline and Shuttle Bag for transport and storage

024-4121 / Shuttle Anchor:
Bolt-on Bracket

024-4124 / Shuttle Anchor:
I-Beam Mount



025-9106 / SHUTTLE BAG

- Multi-purpose durable, reflective, water repellent bag
- Versatile attachment including loop and small magnetic carabiner
- Perfect for use with Shuttle Anchor or separate convenient tool bag



021-4043 / 10K SWIVEL ANCHOR & BACK PLATE

- Versatile use on reinforced cinder block, chillers, metal or AC walls
- Includes 10K swivel anchor, plate, bolt and wingnut



FS886 / STAINLESS STEEL WIRE CLAMP ANCHOR

- Quick and easy to install, no tools required
- Spring-loaded handle to open/close anchor
- For overhead applications only



019-4017 / CAB MOUNT BRACKET

- Compact, lightweight anchor point for SRL-Ps
- Designed for use in order picker forklifts



023-4104 / SCAFFOLD DAVIT ANCHOR: 1.6"- 2" CLAMPS

- Versatile overhead anchor point with flexibility in mounting locations
- Easily installs directly to vertical post with just two clamps
- Horizontal swivel for optimum positioning to reduce swing fall risk
- Locks securely in place to prevent movement during use
- Use for fall arrest or fall restraint with appropriate SRL or lanyard

024-4119 / Scaffold Davit Anchor: 2.25"- 2.75" Clamps

024-4120 / Scaffold Davit Anchor: 2.5"- 3" Clamps



024-24013 / MOUNTED MATERIAL LIFT SYSTEM: 2.5"- 3" CLAMPS

- Versatile material lifting anchor with flexibility in mounting locations
- Easily installs directly to vertical post with just two clamps
- Mechanical advantage while lifting in either 2:1 or 1:1 setup
- Rope lock engages to secure materials and prevent dropped loads
- Includes (2) triple lock carabiners, rope sold separately

024-24012 / Mounted Material Lift System: 2.25"- 2.75" Clamps

023-24004 / Mounted Material Lift System: 1.6"- 2" Clamps



023-24006 / 30' ROPE ASSEMBLY MOUNTED MATERIAL LIFT

- Use with all versions of Mounted Material Lift System
- Provides necessary length of rope for material lifting in 2:1 setup

023-24007 / 60' Rope Assembly Mounted Material Lift

023-24008 / 90' Rope Assembly Mounted Material Lift

023-24010 / Aluminum Rope Lock

023-24009 / Aluminum Hauling Pulley





HARNESSES

We know you've got a job to do. Your harness needs to provide all-day comfort and flexibility without getting in the way of productivity, in addition to keeping you safe in the event of a fall. Our comprehensive line includes a variety of configurations to provide a perfect fit for both you and the job at hand.



PRO ⊕ SLATE

Equipped with aluminum D-rings, moisture wicking breathable padding, effortless aluminum torso adjusters, durable webbing, quick-connect chest buckle and removable belt for tool bags. Offered in both belted and non-belted configurations.



PRO ⊕

Equipped with steel D-rings, moisture wicking breathable padding, effortless aluminum torso adjusters, durable high visibility webbing, quick-connect chest buckle and removable belt for tool bags. Offered in both belted and non-belted configurations.





PRO

Features exclusive comfort pads for all day use, forged steel D-rings, abrasion resistant webbing, spring loaded torso adjusters and removable belt for tool bags. Offered in a wide variety of configurations.



V-SELECT

Innovative and affordable including new breathable pads with moisture and bacteria resistance. Engineered with integrated SRL channel, easy-adjust webbing and corrosion resistant hardware. Offered with consolidated sizes.



V-LINE

Built for diversity, this line offers padded and non-padded models, forged steel D-rings and easily adjusted torso. Available in various configurations.



CONTOUR

The first fall protection harness designed and built BY women especially FOR women. Tailored to the natural curves of the female form, this harness is designed for optimal fit on women of all shapes and sizes. Includes breathable padding, innovative leg straps and an ergonomic shoulder pad.



ARC FLASH

Constructed with mill-spec nylon webbing or superior aramid fiber webbing for protection and durability in the most extreme environments. Soft loops and dielectric coated steel components available in various configurations.



WELDING

Designed for extreme environments and developed to be used by welders or workers that are exposed to flame, fire, high heat and other associated welding processes.

ASK US ABOUT THE NEXT
HARNESSEN SENSATION



SPECIALTY

Unique industry specific products built for a wide variety of applications including: Heavyweight, Wind Energy/Tower Climbing, Oil & Gas, High Visibility and coated.



ACCESSORIES

Comfort and utility upgrades for your harness including waist pad and belt combo, stand-alone belts, removable leg and shoulder pads for extra comfort and our popular replacement lanyard keepers.



1

020-1182 /
**PRO+ SLATE
CONSTRUCTION
HARNESS:** ALU 3D,
ALU QC Chest, ALU FD,
TB Legs

- Lightweight aluminum components
- D-rings: fixed dorsal, front, side
- Premium integrated SRL channel
- Quick torso adjusters
- Pads: fixed waist, removable leg



2

021-1827 /
**PRO+ SLATE
CONSTRUCTION
HARNESS:** ALU 3D,
ALU QC Chest, ALU FD,
ALU QC Legs

- Lightweight aluminum components
- D-rings: fixed dorsal, front
- Premium integrated SRL channel
- Quick torso adjusters
- Pads: fixed waist, removable leg



3

020-1190 /
**PRO+ SLATE
CONSTRUCTION
HARNESS:** ALU 3D,
ALU QC Chest, TB Legs

- Lightweight aluminum components
- D-rings: fixed dorsal, side
- Premium integrated SRL channel
- Quick torso adjusters
- Pads: fixed waist, removable leg



4

021-1819 /
**PRO+ SLATE
CONSTRUCTION
HARNESS:** ALU 3D,
ALU QC Chest/Legs

- Lightweight aluminum components
- D-rings: fixed dorsal, side
- Premium integrated SRL channel
- Quick torso adjusters
- Pads: fixed waist, removable leg



023-1257 / **PRO+ SLATE
CONSTRUCTION
HARNESS:** ALU 3D, ALU QC
Chest, TB Legs, Trauma Relief

- Integrated trauma relief packs



025-1758 / **PRO+ SLATE
CONSTRUCTION
HARNESS:** ALU 3D, ALU QC
Chest/Legs, Trauma Relief

- Integrated trauma relief packs

PRO+ Slate Harness Sizes

	XSMALL	SMALL	MEDIUM	LARGE	XLARGE	2X	3X	4X
1	020-1180	020-1181	020-1182	020-1183	020-1184	020-1185	020-1186	—
2	021-1825	021-1826	021-1827	021-1828	021-1829	021-1830	021-1831	—
3	020-1188	020-1189	020-1190	020-1191	020-1192	020-1193	020-1194	—
3a	023-1255	023-1256	023-1257	023-1258	023-1259	023-1260	023-1261	023-1262
4	021-1817	021-1818	021-1819	021-1820	021-1821	021-1822	021-1823	—
4a	025-1756	025-1757	025-1758	025-1759	025-1760	025-1761	025-1762	025-1763



5

020-1198 / **PRO+ SLATE CONSTRUCTION HARNESS:** ALU 1D, ALU QC Chest, TB Legs

- Lightweight aluminum components
- D-rings: fixed dorsal
- Premium integrated SRL channel
- Quick torso adjusters
- Pads: fixed waist, removable leg



6

024-1480 / **PRO+ SLATE TOWER CONSTRUCTION HARNESS:** ALU 3D, ALU QC Chest, ALU FD, TB Legs, Tower Seat

- Lightweight aluminum components
- D-rings: fixed dorsal, front, side
- Plus side D-rings for positioning/suspension
- Quick torso adjusters
- Pads: fixed waist, removable leg
- Removable, padded tower seat with tool rings (024-9102 pictured below)

PRO+ SLATE



7

024-1488 / **PRO+ SLATE TOWER CONSTRUCTION HARNESS:** ALU 3D, ALU QC CHEST, ALU FD, ALU QC LEGS, TOWER SEAT

- Lightweight aluminum components
- D-rings: fixed dorsal, front, side
- Plus side D-rings for positioning/suspension
- Quick torso adjusters
- Pads: fixed waist, removable leg
- Removable, padded tower seat with tool rings

024-9102 / **PRO+ SLATE TOWER SEAT**



Adjustable seat for a secure, comfortable base while working

PRO+ Slate Harness Sizes

	XSMALL	SMALL	MEDIUM	LARGE	XLARGE	2X	3X	4X
5	020-1196	020-1197	020-1198	020-1199	020-1200	020-1201	020-1202	—
6	024-1478	024-1479	024-1480	024-1481	024-1482	024-1483	024-1484	024-1485
7	024-1486	024-1487	024-1488	024-1489	024-1490	024-1491	024-1492	024-1493



8

025-1766 / **PRO+ SLATE FULL BODY RETRIEVAL HARNESS:** ALU 3D, ALU Shoulder D's, ALU QC Chest, ALU FD, TB Legs

- Lightweight aluminum components
- D-rings: fixed dorsal, front, side
- Plus shoulder retrieval D-rings for rescue
- Premium integrated SRL channel
- Quick torso adjusters
- Pads: removable leg



9

020-1206 / **PRO+ SLATE FULL BODY HARNESS:** ALU 3D, ALU QC Chest, TB Legs

- Lightweight aluminum components
- D-rings: fixed dorsal, side
- Quick torso adjusters
- Premium integrated SRL channel
- Pads: removable leg



10

022-1951 / **PRO+ SLATE FULL BODY RETRIEVAL HARNESS:** ALU 1D, ALU Shoulder D's, ALU QC Chest, ALU FD, TB Legs

- Lightweight aluminum components
- D-rings: fixed dorsal, front
- Plus shoulder retrieval D-rings for rescue
- Premium integrated SRL channel
- Quick torso adjusters
- Pads: removable leg



11

020-1214 / **PRO+ SLATE FULL BODY HARNESS:** Alu 1D, Alu QC Chest, Alu FD, TB Legs

- Lightweight aluminum components
- D-rings: fixed dorsal, front
- Premium integrated SRL channel
- Quick torso adjusters
- Pads: removable leg

PRO+ Slate Harness Sizes

	XSMALL	SMALL	MEDIUM	LARGE	XLARGE	2X	3X	4X
8	025-1764	025-1765	025-1766	025-1767	025-1768	025-1769	025-1770	025-1771
9	020-1204	020-1205	020-1206	020-1207	020-1208	020-1209	020-1210	—
10	—	022-1950	022-1951	022-1952	022-1953	022-1954	022-1955	—
11	020-1212	020-1213	020-1214	020-1215	020-1216	020-1217	020-1218	—



12

O20-1222 / **PRO+ SLATE FULL BODY HARNESS: ALU 1D, ALU QC Chest/Legs**

- Lightweight aluminum components
- D-rings: fixed dorsal
- Premium integrated SRL channel
- Quick torso adjusters
- Pads: removable leg



13

O20-1230 / **PRO+ SLATE FULL BODY HARNESS: ALU 1D, ALU QC Chest, TB Legs**

- Lightweight aluminum components
- D-rings: fixed dorsal
- Premium integrated SRL channel
- Quick torso adjusters
- Pads: removable leg



O23-1265 / **PRO+ SLATE FULL BODY HARNESS: ALU 1D, ALU QC Chest/Legs, Trauma Relief**

- Integrated trauma relief packs

PRO+ Slate Harness Sizes

	XSMALL	SMALL	MEDIUM	LARGE	XLARGE	2X	3X	4X
12	O20-1220	O20-1221	O20-1222	O20-1223	O20-1224	O20-1225	O20-1226	—
12a	O23-1263	O23-1264	O23-1265	O23-1266	O23-1267	O23-1268	O23-1269	O23-1270
13	O20-1228	O20-1229	O20-1230	O20-1231	O20-1232	O20-1233	O20-1234	—

HARNESSES SIZING CHART

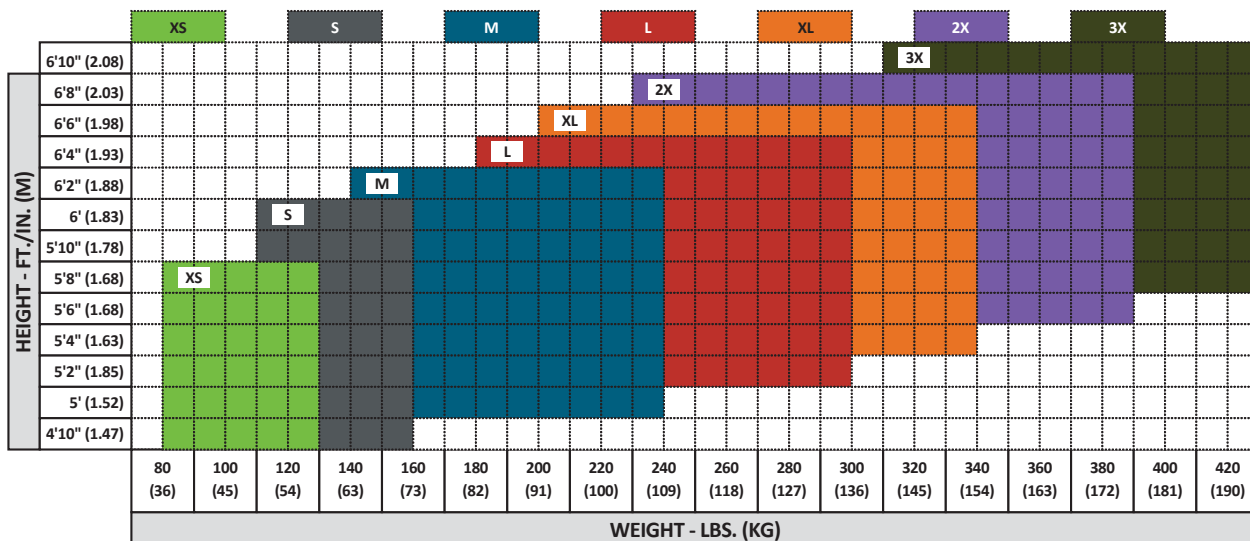

BELT SIZING

Use our sizing guide to find the right size and style of fall protection harness. Proper harness fit is critical for job safety and in the event of a fall.

SIZE	MEASUREMENT	SIZE	MEASUREMENT
XS	28" - 38.5"	XS/S	28.5" - 42.5"
S	32" - 42.5"	S/M	33" - 46.5"
M	36" - 46.5"	M/L	36.5" - 50.5"
L	40" - 50.5"	L/XL	41" - 54.5"
XL	44" - 54.5"	XL/2X	44.5" - 58.5"
2X	48" - 58.5"	2X/3X	49" - 62.5"
3X	52" - 62.5"	3X/4X	53" - 66.5"
4X	56" - 66.5"		



1

FS-FLEX360 / PRO+ CONSTRUCTION HARNESS: 3D, QC Chest, TB Legs

- Durable steel components
- D-rings: fixed dorsal, side
- Premium integrated SRL channel
- Quick torso adjusters
- Pads: floating waist, removable leg



023-1243 / **PRO+ CONSTRUCTION HARNESS: 3D, QC Chest, TB Legs, Trauma Relief**

- Integrated trauma relief packs



2

FS-FLEX270 / PRO+ CONSTRUCTION HARNESS: 3D, QC Chest, TB Legs, TB Torso

- Durable steel components
- D-rings: fixed dorsal, side
- Premium integrated SRL channel
- Iron worker TB torso adjusters
- Pads: fixed waist, removable leg, reinforced shoulder



3

021-1435 / PRO+ CONSTRUCTION HARNESS: 1D, QC Chest, TB Legs

- Durable steel components
- D-rings: fixed dorsal
- Premium integrated SRL channel
- Quick torso adjusters
- Pads: floating waist, removable leg



PRO+ Harness Sizes

	XSMALL	SMALL	MEDIUM	LARGE	XLARGE	2X	3X	4X
1	FS-FLEX360-XS	FS-FLEX360-S	FS-FLEX360-M	FS-FLEX360-L	FS-FLEX360-XL	FS-FLEX360-2X	FS-FLEX360-3X	—
1a	023-1241	023-1242	023-1243	023-1244	023-1245	023-1246	023-1247	023-1248
2	FS-FLEX270-XS	FS-FLEX270-S	FS-FLEX270-M	FS-FLEX270-L	FS-FLEX270-XL	FS-FLEX270-2X	FS-FLEX270-3X	FS-FLEX270-4X
3	021-1433	021-1434	021-1435	021-1436	021-1437	021-1438	021-1439	—

SAFEWAZE PRO+



4

025-1773 / PRO+ FULL BODY RETRIEVAL HARNESS: 3D, SHOULDER D'S, QC CHEST, FD, TB LEGS

- Durable steel components
- D-rings: fixed dorsal, front, side
- Plus shoulder retrieval D-rings for rescue
- Premium integrated SRL channel
- Pads: removable leg



Versatility with multiple D-rings for vertical climbing, confined space and hands-free positioning



5

FS-FLEX285-QC / PRO+ FULL BODY HARNESS: 3D, QC Chest/Legs

- Durable steel components
- D-rings: fixed dorsal, side
- Premium integrated SRL channel
- Quick torso adjusters
- Pads: removable leg



6

FS-FLEX285 / PRO+ FULL BODY HARNESS: 3D, QC Chest, TB Legs

- Durable steel components
- D-rings: fixed dorsal, side
- Premium integrated SRL channel
- Quick torso adjusters
- Pads: removable leg

PRO+ Harness Sizes

	XSMALL	SMALL/ MEDIUM	LARGE / XLARGE	2X	3X	4X
4	025-1772	025-1773	025-1774	025-1775	025-1776	025-1777
5	FS-FLEX285-QC-XS	FS-FLEX285-QC-S/M	FS-FLEX285-QC-L/XL	FS-FLEX285-QC-2X	FS-FLEX285-QC-3X	—
6	FS-FLEX285-XS	FS-FLEX285-S/M	FS-FLEX285-L/XL	FS-FLEX285-2X	FS-FLEX285-3X	—



7

FS-FLEX280-FD/
**PRO+ FULL BODY
HARNESSES:** 1D, QC
Chest, FD, QC Legs

- Durable steel components
- D-rings: fixed dorsal, front
- Premium integrated SRL channel
- Quick torso adjusters
- Pads: removable leg



8

FS-FLEX280/
**PRO+ FULL BODY
HARNESSES:** 1D, QC
Chest/Legs

- Durable steel components
- D-rings: fixed dorsal
- Premium integrated SRL channel
- Quick torso adjusters
- Pads: removable leg



9

FS-FLEX185 / **PRO+
FULL BODY HARNESSES:**
1D, QC Chest, TB Legs

- Durable steel components
- D-rings: fixed dorsal
- Premium integrated SRL channel
- Quick torso adjusters
- Pads: removable leg

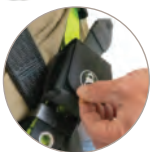

023-1250 / **PRO+ FULL
BODY HARNESSES:** 1D, QC
Chest, TB Legs, Trauma Relief

- Integrated trauma relief packs



PRO+ Harness Sizes

	XSMALL	SMALL/ MEDIUM	LARGE / XLARGE	2X	3X	4X
7	FS-FLEX280-FD-XS	FS-FLEX280-FD-S/M	FS-FLEX280-FD-L/XL	FS-FLEX280-FD-2X	FS-FLEX280-FD-3X	—
8	FS-FLEX280-XS	FS-FLEX280-S/M	FS-FLEX280-L/XL	FS-FLEX280-2X	FS-FLEX280-3X	—
9	FS-FLEX185-XS	FS-FLEX185-S/M	FS-FLEX185-L/XL	FS-FLEX185-2X	FS-FLEX185-3X	—
9a	023-1249	023-1250	023-1251	023-1252	023-1253	023-1254



1

FS170-QC / PRO CONSTRUCTION HARNESS: 3D, QC Chest, TB Legs

- D-rings: fixed dorsal, side
- Premium integrated SRL channel
- Friction buckle torso adjusters
- Pads: fixed waist



2

FS170-M / PRO CONSTRUCTION HARNESS: 3D, MB Chest, TB Legs

- D-rings: fixed dorsal, side
- Premium integrated SRL channel
- Friction buckle torso adjusters
- Pads: fixed waist



023-1229 / PRO CONSTRUCTION HARNESS: 3D, MB Chest, TB Legs, Trauma Relief

- Integrated trauma relief packs



3

021-1451 / PRO CONSTRUCTION HARNESS: 3D, QC Chest/Legs

- D-rings: fixed dorsal, side
- Premium integrated SRL channel
- Friction buckle torso adjusters
- Pads: floating waist



4

FS160 / PRO CONSTRUCTION HARNESS: 3D, MB Chest, TB Legs

- D-rings: fixed dorsal, side
- Premium integrated SRL channel
- Friction buckle torso adjusters
- Pads: floating waist

PRO Harness Sizes

	XSMALL	SMALL	MEDIUM	LARGE	XLARGE	2X	3X	4X
1	FS170-QC-XS	FS170-QC-S	FS170-QC-M	FS170-QC-L	FS170-QC-XL	FS170-QC-2X	FS170-QC-3X	—
2	FS170-XS	FS170-S	FS170-M	FS170-L	FS170-XL	FS170-2X	FS170-3X	—
2a	023-1227	023-1228	023-1229	023-1230	023-1231	023-1232	023-1233	023-1234
3	021-1449	021-1450	021-1451	021-1452	021-1453	021-1454	021-1455	—
4	FS160-XS	FS160-S	FS160-M	FS160-L	FS160-XL	FS160-2X	FS160-3X	—



5

021-1443 /
PRO CONSTRUCTION HARNESS: 1D, QC Chest, TB Legs

- D-rings: fixed dorsal
- Premium integrated SRL channel
- Friction buckle torso adjusters
- Pads: fixed waist



6

019-1063 /
PRO FULL BODY HARNESS: 3D, MB Chest, FD, TB Legs

- D-rings: fixed dorsal, front, side
- Premium integrated SRL channel
- Friction buckle torso adjusters



7

FS285-QC /
PRO FULL BODY HARNESS: 3D, QC Chest, TB Legs

- D-rings: fixed dorsal, side
- Premium integrated SRL channel
- Friction buckle torso adjusters



8

FS285 /
PRO FULL BODY HARNESS: 3D, MB Chest, TB Legs

- D-rings: fixed dorsal, side
- Premium integrated SRL channel
- Friction buckle torso adjusters

PRO Harness Sizes

	XSMALL	SMALL	MEDIUM	LARGE	XLARGE	2X	3X
5	021-1441	021-1442	021-1443	021-1444	021-1445	021-1446	021-1447
	XSMALL	SMALL/ MEDIUM	LARGE / XLARGE	2X	3X		
6	019-1062	019-1063	019-1064	019-1065	—		
7	FS285-QC-XS	FS285-QC-S/M	FS285-QC-L/XL	FS285-QC-2X	FS285-QC-3X		
8	FS285-XS	FS285-S/M	FS285-L/XL	FS285-2X	FS285-3X		



9

FS281/ PRO FULL BODY HARNESS: 3D, MB Chest/Legs

- D-rings: fixed dorsal, side
- Premium integrated SRL channel
- Friction buckle torso adjusters



10

SW280-QC/ PRO FULL BODY HARNESS: 1D, QC Chest/Legs

- D-rings: dorsal
- Premium integrated SRL channel
- Friction buckle torso adjusters



11

FS185-QC/ PRO FULL BODY HARNESS: 1D, QC Chest, TB Legs

- D-rings: fixed dorsal
- Premium integrated SRL channel
- Friction buckle torso adjusters



12

FS185-R/ PRO FULL BODY RETRIEVAL HARNESS: 1D, Shoulder D, MB Chest, TB Legs

- D-rings: fixed dorsal
- Plus shoulder retrieval D-rings for rescue
- Premium integrated SRL channel
- Friction buckle torso adjusters

PRO Harness Sizes

	XSMALL	SMALL/ MEDIUM	LARGE / XLARGE	2X	3X
9	FS281-XS	FS281-S/M	FS281-L/XL	FS281-2X	FS281-3X
10	SW280-QC-XS	SW280-QC-S/M	SW280-QC-L/XL	SW280-QC-2X	SW280-QC-3X
11	FS185-QC-XS	FS185-QC-S/M	FS185-QC-L/XL	FS185-QC-2X	FS185-QC-3X
12	FS185-R-XS	FS185-R-S/M	FS185-R-L/XL	FS185-R-2X	FS185-R-3X



13

FS185-FD / **PRO FULL BODY HARNESSES: 1D, MB Chest, FD, TB Legs**

- D-rings: fixed dorsal, front
- Premium integrated SRL channel
- Friction buckle torso adjusters



14

FS185 / **PRO FULL BODY HARNESSES: 1D, MB Chest, TB Legs**

- D-rings: fixed dorsal
- Premium integrated SRL channel
- Friction buckle torso adjusters



023-1236 / **PRO FULL BODY HARNESSES: 1D, MB Chest, TB Legs, Trauma Relief**

- Integrated trauma relief packs



15

FS280 / **PRO FULL BODY HARNESSES: 1D, MB Chest/Legs**

- D-rings: fixed dorsal
- Premium integrated SRL channel
- Friction buckle torso adjusters



PRO Harness Sizes

	XSMALL	SMALL/ MEDIUM	LARGE / XLARGE	2X	3X	4X
13	FS185-FD	FS185-FD-S/M	FS185-FD-L/XL	FS185-FD-2X	FS185-FD-3X	—
14	FS185-XS	FS185-S/M	FS185-L/XL	FS185-2X	FS185-3X	—
14a	023-1235	023-1236	023-1237	023-1238	023-1239	023-1240
15	FS280-XS	FS280-S/M	FS280-L/XL	FS280-2X	FS280-3X	—
16	024-1610	024-1611	024-1612	024-1613	024-1614	024-1615

SAFEWAZE PRO

16

024-1611 / PRO CONFINED SPACE FBH: 3D, QC CHEST/LEGS, SUSPENSION SLING

- Built-in sling seat for easy entry/exit
- Premium integrated SRL channel
- D-rings: fixed dorsal, stowable suspension
- Friction buckle torso adjusters
- Pads: floating waist



Narrow profile for seamless access in tight environments



V-SELECT

HARNESSES

1

021-1715 / V-SELECT CONSTRUCTION HARNESS: 3D, QC Chest, FD, TB Legs

- D-rings: fixed dorsal, front, side
- Integrated SRL channel
- Friction buckle torso adjusters
- Breakaway lanyard keepers
- Pads: fixed waist



2

021-1721 / V-SELECT CONSTRUCTION HARNESS: 3D, QC Chest/Legs

- D-rings: fixed dorsal, side
- Integrated SRL channel
- Friction buckle torso adjusters
- Breakaway lanyard keepers
- Pads: fixed waist



Select Models with Integrated Trauma Relief, Call for Availability

V-Select Harness Sizes

	XSMALL/SMALL	MEDIUM/LARGE	XLARGE/2X	3X
1	021-1714	021-1715	021-1716	021-1717
2	021-1720	021-1721	021-1722	021-1723



3

021-1727 / **V-SELECT CONSTRUCTION HARNESS: 3D, QC Chest, TB Legs**

- D-rings: fixed dorsal, side
- Integrated SRL channel
- Friction buckle torso adjusters
- Breakaway lanyard keepers
- Pads: fixed waist



4

021-1739 / **V-SELECT CONSTRUCTION HARNESS: 1D, QC Chest, TB Legs**

- D-rings: fixed dorsal
- Integrated SRL channel
- Friction buckle torso adjusters
- Breakaway lanyard keepers
- Pads: fixed waist



5

022-1070 / **V-SELECT RETRIEVAL FBH: 3D, QC CHEST, FD, SHOULDER DS, TB LEGS, LEG PADS**

- D-rings: fixed dorsal, front, side
- Plus shoulder retrieval D-rings for rescue
- Integrated SRL channel
- Friction buckle torso adjusters
- Breakaway lanyard keepers
- Pads: removable leg

All V-Select harnesses feature specially engineered easy-adjust webbing



V-SELECT

Select Models with Integrated Trauma Relief, Call for Availability

V-Select Harness Sizes

	XSMALL/SMALL	MEDIUM/LARGE	XLARGE/2X	3X
3	021-1726	021-1727	021-1728	021-1729
4	021-1738	021-1739	021-1740	021-1741
5	022-1069	022-1070	022-1071	022-1072



6

021-1745 / **V-SELECT FULL BODY HARNESS:**
3D, QC Chest, FD,
TB Legs

- D-rings: fixed dorsal, front, side
- Integrated SRL channel
- Friction buckle torso adjusters
- Breakaway lanyard keepers



7

021-1751 / **V-SELECT FULL BODY HARNESS:**
3D, QC Chest/Legs

- D-rings: fixed dorsal, side
- Integrated SRL channel
- Friction buckle torso adjusters
- Breakaway lanyard keepers



8

021-1769 / **V-SELECT FULL BODY HARNESS:**
1D, QC Chest/Legs

- D-rings: fixed dorsal
- Integrated SRL channel
- Friction buckle torso adjusters
- Breakaway lanyard keepers



9

022-1075 / **V-SELECT FULL BODY HARNESS:**
1D, MB Chest, FD,
TB Legs

- D-rings: fixed dorsal, front
- Integrated SRL channel
- Friction buckle torso adjusters
- Breakaway lanyard keepers

Select Models with Integrated Trauma Relief, Call for Availability

V-Select Harness Sizes

	XSMALL/SMALL	MEDIUM/LARGE	XLARGE/2X	3X
6	021-1744	021-1745	021-1746	021-1747
7	021-1750	021-1751	021-1752	021-1753
8	021-1768	021-1769	021-1770	021-1771
9	022-1074	022-1075	022-1076	022-1077



10

022-1080 / V-SELECT FULL BODY HARNESS: 1D, QC Chest, TB Legs

- D-rings: fixed dorsal
- Integrated SRL channel
- Friction buckle torso adjusters
- Breakaway lanyard keepers



11

021-1775 / V-SELECT FULL BODY HARNESS: 1D, MB Chest, TB Legs

- D-rings: fixed dorsal
- Integrated SRL channel
- Friction buckle torso adjusters
- Breakaway lanyard keepers



12

022-1899 / V-SELECT CROSSOVER HARNESS: 3D, QC Torso, FD, QC Legs

- D-rings: fixed dorsal, front, side
- Integrated SRL channel
- Upper & lower torso adjusters
- Breakaway lanyard keepers



13

022-1085 / V-SELECT CROSSOVER HARNESS: 1D, QC Torso, FD, TB Legs

- D-rings: fixed dorsal, front
- Integrated SRL channel
- Upper & lower torso adjusters
- Breakaway lanyard keepers

Select Models with Integrated Trauma Relief, Call for Availability

V-Select Harness Sizes

	XSMALL/SMALL	MEDIUM/LARGE	XLARGE/2X	3X
10	022-1079	022-1080	022-1081	022-1082
11	021-1774	021-1775	021-1776	021-1777
12	022-1898	022-1899	022-1900	022-1901
13	022-1084	022-1085	022-1086	022-1087



1

FS99160-E / **V-LINE CONSTRUCTION HARNESS:** 3D, MB Chest, TB Legs

- D-rings: fixed dorsal, side
- Friction buckle torso adjusters
- Pads: floating waist



2

FS99285-E / **V-LINE FULL BODY HARNESS:** Universal, 3D, MB Chest, TB Legs

- Universal sizing
- D-rings: dorsal, side
- Mating buckle torso adjusters



3

FS99281-EFD / **V-LINE FULL BODY HARNESS:** Universal, 3D, MB Chest, FD, MB Legs

- Universal sizing
- D-rings: fixed dorsal, front, side
- Mating buckle torso adjusters



4

FS99281-E / **V-LINE FULL BODY HARNESS:** Universal, 3D, MB Chest/Legs

- Universal sizing
- D-rings: fixed dorsal, side
- Mating buckle torso adjusters



5

FS99185-E / **V-LINE FULL BODY HARNESS:** Universal, 1D, MB Chest, TB Legs

- Universal sizing
- D-rings: fixed dorsal
- Mating buckle torso adjusters



6

FS99280-E / **V-LINE FULL BODY HARNESS:** Universal, 1D, MB Chest/Legs

- Universal sizing
- D-rings: fixed dorsal
- Mating buckle torso adjusters

V-Line Harness Sizes

	SMALL	MEDIUM	LARGE	XLARGE	2X
1	FS99160-E-S	FS99160-E-M	FS99160-E-L	FS99160-E-XL	FS99160-E-2X



1

025-1634 / **CONTOUR CONSTRUCTION HARNESS: 3D, QC Chest, FD, TB Legs**

- D-rings: fixed dorsal, front, side
- Premium integrated SRL channel
- Mating buckle torso adjusters (two each side)
- Breakaway lanyard keepers
- Pads: floating waist, ergonomic shoulder



2

025-1642 / **CONTOUR CONSTRUCTION HARNESS: 3D, QC Chest, TB Legs**

- D-rings: fixed dorsal, side
- Premium integrated SRL channel
- Mating buckle torso adjusters (two each side)
- Breakaway lanyard keepers
- Pads: floating waist, ergonomic shoulder



3

025-1650 / **CONTOUR CONSTRUCTION HARNESS: 3D, QC CHEST/LEGS**

- D-rings: fixed dorsal, side
- Premium integrated SRL channel
- Mating buckle torso adjusters (two each side)
- Breakaway lanyard keepers
- Pads: floating waist, ergonomic shoulder

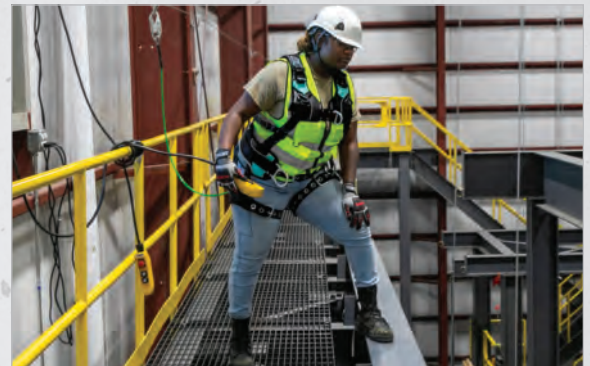

Contour is built for comfort and fit with breathable padding, extreme adjustability and innovative leg straps

Contour Harness Sizes

	XSMALL	SMALL	MEDIUM	LARGE	XLARGE	2X	3X
1	025-1632	025-1633	025-1634	025-1635	025-1636	025-1637	025-1638
2	025-1640	025-1641	025-1642	025-1643	025-1644	025-1645	025-1646
3	025-1648	025-1649	025-1650	025-1651	025-1652	025-1653	025-1654



4

025-1658 / **CONTOUR FULL BODY HARNESS:**
3D, QC Chest, FD,
TB Legs

- D-rings: fixed dorsal, front, side
- Premium integrated SRL channel
- Mating buckle torso adjusters (two each side)
- Breakaway lanyard keepers
- Pads: ergonomic shoulder



5

025-1666 / **CONTOUR FULL BODY HARNESS:**
3D, QC Chest, TB Legs

- D-rings: fixed dorsal, side
- Premium integrated SRL channel
- Mating buckle torso adjusters (two each side)
- Breakaway lanyard keepers
- Pads: ergonomic shoulder



6

025-1674 / **CONTOUR FULL BODY HARNESS:**
3D, QC Chest/Legs

- D-rings: fixed dorsal, side
- Premium integrated SRL channel
- Mating buckle torso adjusters (two each side)
- Breakaway lanyard keepers
- Pads: ergonomic shoulder



7

025-1682 / **CONTOUR FULL BODY HARNESS:**
1D, QC Chest, FD,
TB Legs

- D-rings: fixed dorsal, front
- Premium integrated SRL channel
- Mating buckle torso adjusters (two each side)
- Breakaway lanyard keepers
- Pads: ergonomic shoulder

Contour Harness Sizes

	XSMALL	SMALL	MEDIUM	LARGE	XLARGE	2X	3X
4	025-1656	025-1657	025-1658	025-1659	025-1660	025-1661	025-1662
5	025-1664	025-1665	025-1666	025-1667	025-1668	025-1669	025-1670
6	025-1672	025-1673	025-1674	025-1675	025-1676	025-1677	025-1678
7	025-1680	025-1681	025-1682	025-1683	025-1684	025-1685	025-1686



8

025-1690 / **CONTOUR FULL BODY HARNESS:** 1D, QC Chest, TB Legs

- D-rings: fixed dorsal
- Premium integrated SRL channel
- Mating buckle torso adjusters (two each side)
- Breakaway lanyard keepers
- Pads: ergonomic shoulder



9

025-1698 / **CONTOUR FULL BODY HARNESS:** 1D, QC Chest/Legs

- D-rings: fixed dorsal
- Premium integrated SRL channel
- Mating buckle torso adjusters (two each side)
- Breakaway lanyard keepers
- Pads: ergonomic shoulder

Contour Harness Sizes

	XSMALL	SMALL	MEDIUM	LARGE	XLARGE	2X	3X
8	025-1688	025-1689	025-1690	025-1691	025-1692	025-1693	025-1694
9	025-1696	025-1697	025-1698	025-1699	025-1700	025-1701	025-1702



1

ARC FLASH (ARAMID)

020-1252 / **ARC FLASH CONSTRUCTION HARNESS:** DE 3D, DE QC CHEST, DE FD, DE QC LEGS

- Dielectric D-rings: dorsal, front, side
- Dielectric QC chest, legs, belt
- Dielectric MB torso adjusters
- Nomex® pads: fixed waist, leg, shoulder
- 40Cal/700F char rated aramid webbing



Built for utility and electrical workers with premium aramid webbing for dependable protection



2

020-1260 / **ARC FLASH CONSTRUCTION HARNESS:** DE 3D, DE QC Chest, TB Legs

- Dielectric D-rings: dorsal, side
- Dielectric QC chest
- Dielectric MB torso adjusters
- Protective backer for legs, belt
- Nomex® pads: fixed waist, leg, shoulder
- 40Cal/700F char rated aramid webbing



3

020-1346 / **ARC FLASH CONSTRUCTION HARNESS:** 3D, MB Chest, TB Legs

- Steel D-rings: dorsal, side
- Friction buckle torso adjusters
- Protective backer for torso, chest, legs, belt
- Nomex® pads: fixed waist, leg, shoulder
- 40Cal/700F char rated aramid webbing



4

020-1268 / **ARC FLASH FULL BODY HARNESS:** DE 3D, DE QC Chest, DE FD, TB Legs

- Dielectric D-rings: dorsal, front, side
- Dielectric QC chest
- Dielectric MB torso adjusters
- Protective backer for legs
- Nomex® pads: leg, shoulder
- 40Cal/700F char rated aramid webbing



5

022-1038 / **ARC FLASH FULL BODY HARNESS:** DE 3D, DE QC Chest, DE FD, DE QC Legs

- Dielectric D-rings: dorsal, front, side
- Dielectric QC chest, legs
- Dielectric MB torso adjusters
- Nomex® pads: leg, shoulder
- 40Cal/700F char rated aramid webbing

Arc Flash Harness Sizes

	XSMALL	SMALL	MEDIUM	LARGE	XLARGE	2X	3X
1	020-1250	020-1251	020-1252	020-1253	020-1254	020-1255	020-1256
2	020-1258	020-1259	020-1260	020-1261	020-1262	020-1263	020-1264
3	020-1344	020-1345	020-1346	020-1347	020-1348	020-1349	020-1350
4	020-1266	020-1267	020-1268	020-1269	020-1270	020-1271	020-1272
5	022-1036	022-1037	022-1038	022-1039	022-1040	022-1041	022-1042



6

022-1016 / **ARC FLASH FULL BODY HARNESS:** DE 3D, DE QC Chest/Legs

- Dielectric D-rings: dorsal, side
- Dielectric QC chest, legs
- Dielectric MB torso adjusters
- Nomex® pads: leg, shoulder
- 40Cal/700F char rated aramid webbing



7

020-1276 / **ARC FLASH FULL BODY HARNESS:** DE 3D, DE MB Chest/Legs

- Dielectric D-rings: dorsal, side
- Dielectric MB chest, legs, torso adjusters
- Nomex® pads: leg, shoulder
- 40Cal/700F char rated aramid webbing



8

022-1982 / **ARC FLASH FULL BODY HARNESS:** DE 1D, DE QC Chest/Legs

- Dielectric D-rings: dorsal
- Dielectric QC chest, legs
- Dielectric MB torso adjusters
- Nomex® pads: leg, shoulder
- 40Cal/700F char rated aramid webbing



9

020-1284 / **ARC FLASH FULL BODY HARNESS:** DE 1D, DE MB Chest, TB Legs

- Dielectric D-rings: dorsal
- Dielectric MB chest, torso adjusters
- Protective backer for legs
- Nomex® pads: leg, shoulder
- 40Cal/700F char rated aramid webbing

Arc Flash Harness Sizes

	XSMALL	SMALL	MEDIUM	LARGE	XLARGE	2X	3X
6	022-1014	022-1015	022-1016	022-1017	022-1018	022-1019	022-1020
7	020-1274	020-1275	020-1276	020-1277	020-1278	020-1279	020-1280
8	022-1980	022-1981	022-1982	022-1983	022-1984	022-1985	022-1986
9	020-1282	020-1283	020-1284	020-1285	020-1286	020-1287	020-1288



10

020-1292 / ARC FLASH FULL BODY HARNESS: DE 1D, DE MB Chest/Legs

- Dielectric D-rings: dorsal
- Dielectric MB chest, legs, torso adjusters
- Nomex® pads: leg, shoulder
- 40Cal/700F char rated aramid webbing



11

020-1354 / ARC FLASH FULL BODY HARNESS: 1D, MB Chest, TB Legs

- Steel D-rings: dorsal
- Friction buckle torso adjusters
- Protective backer for torso, chest, legs
- Nomex® pads: leg, shoulder
- 40Cal/700F char rated aramid webbing



12

024-1379 / ARC FLASH WIND & TOWER HARNESS: 5D, QC Legs

- Dielectric D-rings: dorsal, sternal, front-waist, side
- Dielectric legs
- Aluminum quick torso adjusters with protective backer
- Nomex® and Kevlar® pads: waist, leg, shoulder
- 40Cal/700F char rated aramid webbing



13

024-1385 / ARC FLASH WIND & TOWER HARNESS: 5D, Removable Seat, QC Legs

- Same features as model 024-1379
- Includes positioning/suspension seat

024-9091 / ARC FLASH REMOVABLE TOWER SUSPENSION SEAT

- Adjustable Aramid webbing straps
- Nomex® laminated pad with flexible side panels
- Aluminum foundation
- Pad backed with fire- and abrasion-resistant panel

Arc Flash Harness Sizes

	XSMALL	SMALL	MEDIUM	LARGE	XLARGE	2X	3X
10	020-1290	020-1291	020-1292	020-1293	020-1294	020-1295	020-1296
11	020-1352	020-1353	020-1354	020-1355	020-1356	020-1357	020-1358
	SMALL/MEDIUM		LARGE/XLARGE		2X		
12	024-1379		024-1380		024-1381		
13	024-1385		024-1386		024-1387		

ARC FLASH (NYLON)



1

SW77125-UTQC / ARC FLASH FULL BODY HARNESS: DE 1D, Soft Sternal Loop, DE MB Torso, DE QC Legs

- D-rings: dielectric dorsal, soft loop front
- Dielectric QC legs
- Dielectric MB torso adjusters
- Pullover construction
- 40Cal/550F char rated nylon webbing



2

SW77125-UTQC-SL / ARC FLASH FULL BODY HARNESS: Soft Dorsal & Sternal Loop, DE MB Torso, DE QC Legs

- D-rings: soft loop dorsal, soft loop front
- Dielectric QC legs
- Dielectric MB torso adjusters
- Pullover construction
- 40Cal/550F char rated nylon webbing



3

024-1538 / ARC FLASH FULL BODY RETRIEVAL HARNESS: SL 3D, SL Shoulder D's, DE QC Chest, DE FD, DE QC Legs

- Soft loop D-rings: dorsal, side, shoulder retrieval
- Dielectric D-rings: front
- Dielectric QC chest, legs
- Aramid soft loops and retrieval handle
- 40Cal/550F char rated nylon webbing

Arc Flash Harness Sizes

	XSMALL	SMALL/MEDIUM	LARGE/XLARGE	2X	3X	4X
1	SW77125-UTQC-XS	SW77125-UTQC-S/M	SW77125-UTQC-L/XL	SW77125-UTQC-2X	SW77125-UTQC-3X	SW77125-UTQC-4X
2	SW77125-UTQC-SL-XS	SW77125-UTQC-SL-S/M	SW77125-UTQC-SL-L/XL	SW77125-UTQC-SL-2X	SW77125-UTQC-SL-3X	SW77125-UTQC-SL-4X
3	024-1537	024-1538	024-1539	024-1540	024-1541	024-1542



4

024-1431/ **ARC FLASH FULL BODY HARNESS:** DE 3D, DE MB Torso, DE QC Chest/Legs

- Dielectric D-rings: dorsal, side
- Dielectric QC chest, legs
- Dielectric MB torso adjusters
- 40Cal/550F char rated nylon webbing



5

SW77225-UT3QC / **ARC FLASH FULL BODY HARNESS:** DE 1D, DE MB Torso, DE QC Chest/Legs

- Dielectric D-rings: dorsal
- Dielectric QC chest, legs
- Dielectric MB torso adjusters
- 40Cal/550F char rated nylon webbing



6

SW77225-UTQC-XS / **ARC FLASH FULL BODY HARNESS:** DE 1D, DE MB Torso, DE MB Chest, DE QC Legs

- Dielectric D-rings: dorsal
- Dielectric QC legs
- Dielectric MB chest, torso adjusters
- 40Cal/550F char rated nylon webbing



7

SW77225-UT2QCSSL / **ARC FLASH FULL BODY HARNESS:** Soft Loop 1D, DE MB Torso, DE MB Chest, DE QC Legs

- D-rings: soft loop dorsal
- Dielectric QC legs
- Dielectric MB chest, torso adjusters
- 40Cal/550F char rated nylon webbing

Arc Flash Harness Sizes

	XSMALL	SMALL/MEDIUM	LARGE/XLARGE	2X	3X	4X
4	024-1430	024-1431	024-1432	024-1433	024-1434	024-1435
5	SW77225-UT3QC-XS	SW77225-UT3QC-S/M	SW77225-UT3QC-L/XL	SW77225-UT3QC-2X	SW77225-UT3QC-3X	SW77225-UT3QC-4X
6	SW77225-UTQC-XS	SW77225-UTQC-S/M	SW77225-UTQC-L/XL	SW77225-UTQC-2X	SW77225-UTQC-3X	SW77225-UTQC-4X
7	SW77225-UT2QCSSL-XS	SW77225-UT2QCSSL-S/M	SW77225-UT2QCSSL-L/XL	SW77225-UT2QCSSL-2X	SW77225-UT2QCSSL-3X	SW77225-UT2QCSSL-4X



1

025-1838 / V-SELECT HOT WORK CONSTRUCTION HARNESS: 3D, QC CHEST, TB LEGS

- Slag, flame and heat resistant
- D-rings: fixed dorsal, side
- Integrated SRL channel
- Friction buckle torso adjusters
- Breakaway lanyard keepers
- High-temp resistant pads: shoulder, waist, leg
- 40Cal/600F char rated aramid sheathed webbing



2

025-1916 / V-SELECT HOT WORK FULL BODY HARNESS: 3D, FD, MB Chest/Legs

- Slag, flame and heat resistant
- D-rings: fixed dorsal, front, side
- Integrated SRL channel
- Friction buckle torso adjusters
- Breakaway lanyard keepers
- High-temp resistant pads: shoulder
- 40Cal/600F char rated aramid sheathed webbing



3

025-1843 / V-SELECT HOT WORK FULL BODY HARNESS: 1D, QC Chest, TB Legs

- Slag, flame and heat resistant
- D-rings: fixed dorsal
- Integrated SRL channel
- Friction buckle torso adjusters
- Breakaway lanyard keepers
- High-temp resistant pads: shoulder
- 40Cal/600F char rated aramid sheathed webbing

V-Select Hot Work Harness Sizes

	XSMALL/SMALL	MEDIUM/LARGE	XLARGE/2X	3X
1	025-1837	025-1838	025-1839	025-1840
2	025-1915	025-1916	025-1917	025-1918
3	025-1842	025-1843	025-1844	025-1845
4	025-1847	025-1848	025-1849	025-1850



4

025-1848 / **V-SELECT HOT WORK FULL BODY HARNESS: 1D, MB Chest/Legs**

- Slag, flame and heat resistant
- D-rings: fixed dorsal, side
- Integrated SRL channel
- Friction buckle torso adjusters
- Breakaway lanyard keepers
- High-temp resistant pads: shoulder
- 40Cal/600F char rated aramid sheathed webbing



5

FS77326-FR / **WELDING FULL BODY HARNESS: 3D, Aramid Web, MB Chest/Legs**

- D-rings: fixed dorsal, side
- Friction buckle torso adjusters
- 40Cal/750F char rated aramid webbing
- Lightweight, superior protection



6

FS77325-FR / **WELDING FULL BODY HARNESS: 1D, Aramid Web, MB Chest/Legs**

- D-rings: fixed dorsal
- Friction buckle torso adjusters
- 40Cal/750F char rated aramid webbing
- Lightweight, superior protection

Welding Harness Sizes

	XSMALL	SMALL	MEDIUM	LARGE	XLARGE	2X	3X
5	FS77326-FR-XS	FS77326-FR-S	FS77326-FR-M	FS77326-FR-L	FS77326-FR-XL	FS77326-FR-2X	FS77326-FR-3X
6	FS77325-FR-XS	FS77325-FR-S	FS77325-FR-M	FS77325-FR-L	FS77325-FR-XL	FS77325-FR-2X	FS77325-FR-3X



7

FS77426-WE /
**WELDING FULL BODY
HARNESSES:** 3D, MB
Chest/Legs

- D-rings: dorsal, side
- Friction buckle torso adjusters
- 40Cal/700F char rated aramid webbing



8

FS77425-WE /
**WELDING FULL BODY
HARNESSES:** 1D, MB
Chest/Legs

- D-rings: dorsal
- Friction buckle torso adjusters
- 40Cal/700F char rated aramid webbing

Welding Harness Sizes

	XSMALL	SMALL/MEDIUM	MEDIUM/LARGE	2X	3X
7	FS77426-WE-XS	FS77426-WE-S/M	FS77426-WE-L/XL	FS77426-WE-2X	FS77426-WE-3X
8	FS77425-WE-XS	FS77425-WE-S/M	FS77425-WE-L/XL	FS77425-WE-2X	FS77425-WE-3X



1

SW99281-HW /
**HEAVYWEIGHT FULL
BODY HARNESSES:** 3D,
MB Chest, TB Legs

- Thicker, stronger webbing
- D-rings: fixed dorsal, side
- Integrated SRL channel
- Friction buckle torso adjusters



2

SW99280-HW /
**HEAVYWEIGHT FULL
BODY HARNESSES:** 1D,
MB Chest, TB Legs

- Thicker, stronger webbing
- D-rings: fixed dorsal
- Integrated SRL channel
- Friction buckle torso adjusters

Heavyweight Speciality Harness Sizes

	3X/4X	5X
1	SW99281-HW	SW99281-HW-5X
2	SW99280-HW	SW99280-HW-5X



3

FS77635-OD / OIL & GAS FULL BODY HARNESS: 1D, Derrick Belt, Alu QC Chest, FD, TB Legs

- D-rings: dorsal, front
- 18" Dorsal D-ring Extender
- Friction buckle torso adjusters
- Rugged belt with QC buckles

FS77635-OD-PAD / REPLACEMENT: Derrick Belt



4

FS227T / WIND & TOWER HARNESS: Alu 5D, Removable Seat, Alu QC Legs

- Ideal for climbing, rescue and rope access
- D-rings: dorsal, sternal, front-waist, side
- Quick torso adjusters
- Web tool loops, removable lanyard keepers
- Pads: waist, leg
- Includes positioning/suspension seat

FS227 / WIND & TOWER HARNESS: Alu 5D, Alu QC Legs

- (seat sold separately)

021-9058 / REMOVABLE TOWER SUSPENSION SEAT

- (sold separately)



5

FS377 / WIND & TOWER CONSTRUCTION HARNESS: Alu 3D, Alu QC Chest, Alu FD, TB Legs

- D-rings: dorsal, front, side
- Quick torso adjusters
- Pads: floating waist, removable leg



6

FS9000-COS / WIND & TOWER CROSSOVER HARNESS: Alu 3D, Alu QC Torso, Alu FD, Alu QC legs

- Universal sizing
- D-rings: dorsal, front, side
- Quick torso adjusters

Specialty Harness Sizes

	SMALL/MEDIUM		LARGE/XLARGE		2X
3	FS77635-OD-S/M		FS77635-OD-L/XL		FS77635-OD-2X
3a	FS77635-OD-PAD-S/M		FS77635-OD-PAD-L/XL		FS77635-OD-PAD-2X
4	FS227T-S/M		FS227T-L/XL		FS227T-2X
4a	FS227-S/M		FS227-L/XL		FS227-2X
	SMALL	MEDIUM	LARGE	XLARGE	2X
5	FS377-S	FS377-M	FS377-L	FS377-XL	FS377-2X



7

FS-HIVIS185 / **REFLECTIVE FULL BODY HARNESS:** 1D, MB Chest, TB Legs

- High-visibility green with reflective tracers
- D-rings: dorsal
- Friction buckle torso adjusters



8

021-1811 / **REFLECTIVE FULL BODY HARNESS:** 1D, MB Chest, TB legs, Mining belt

- Designed for mining
- High-visibility green with reflective tracers
- Attachments for hands-free storage
- Adjustable waist belt to stow lamp
- D-rings: dorsal
- Friction buckle torso adjusters



9

023-1329 / **PRO-SHIELD FULL BODY HARNESS:** 3D, DE MB Chest, TB Legs

- D-rings: dorsal, side
- Dielectric mating buckle torso adjusters
- Improved water and chemical resistance
- Easy-clean, durable coated webbing



10

023-1335 / **PRO-SHIELD FULL BODY HARNESS:** 1D, DE MB Chest, TB Legs

- D-rings: dorsal
- Dielectric mating buckle torso adjusters
- Improved water and chemical resistance
- Easy-clean, durable coated webbing

Specialty Harness Sizes

	SMALL/MEDIUM		LARGE/ XLARGE		2X	
7	FS-HIVIS185-S/M		FS-HIVIS185-L/XL		FS-HIVIS185-2X	
	SMALL	MEDIUM	LARGE	XLARGE	2X	3X
8	021-1810	021-1811	021-1812	021-1813	021-1814	021-1815
	XS	SMALL/MEDIUM	LARGE/ XLARGE		2X	3X
9	023-1328	023-1329	023-1330	023-1331	023-1332	023-1332
10	023-1334	023-1335	023-1336	023-1337	023-1338	023-1338

FULL-BODY HARNESS FITTING

A loose harness may not protect you in a fall and can pose a choking hazard, while one that's too tight can cause discomfort or injury such as muscle strains or a pinched nerve. Proper sizing and adjustment are both essential— follow the steps below with a correctly sized harness to ensure the right fit.



1

Pull leg straps between legs and connect to opposite ends. For a belted harness, connect waist strap to leg straps.

Position extra seat strap below the sub-pelvic strap.

2

Fasten chest strap across chest. Chest strap should be comfortably snug.

Chest strap should NOT be close to user's neck, as strap may contact neck if back D-ring slides up during fall arrest. The chest strap should sit right where your rib cage splits.

3

Use two buckles at base of shoulder straps to adjust shoulder straps. After all straps are buckled, tighten all buckles so that harness fits snug and allows full range of movement.

Secure excess strap in strap keepers.

1



FS2011/ **PRO WAIST PAD & BELT**

- Positioning belt with side D-rings
- Large padded waist area for comfort
- Webbed belt holds pad securely in place

2



FSBELT-2D-RINGS / **POSITIONING BELT**

- Positioning belt with side D-rings

3



021-9043 / **REPLACEMENT BELT**

4



SW111/ **COMFORT LEG PADS**

- Quick velcro attachment to most harnesses
- Open air mesh padding for ventilation

5



021-9038/ **REPLACEMENT LANYARD KEEPERS**

- Save money on harness replacements
- Split D-ring design protects keeper from damage

6



021-9070 / **REMOVABLE SHOULDER PAD**

- Easily secured with 5 velcro attachment points
- Durable outer layer, lightweight linings, anti-bacterial padding

Accessories Sizes

	XSMALL	SMALL	MEDIUM	LARGE	XL	2X	3X	4X
1	FS2011-XS	FS2011-S	FS2011-M	FS2011-L	FS2011-XL	FS2011-2X	FS2011-3X	FS2011-4X
2	—	FSBELT-2D-RINGS-S	FSBELT-2D-RINGS-M	FSBELT-2D-RINGS-L	FSBELT-2D-RINGS-XL	FSBELT-2D-RINGS-2X	—	—
3	021-9041	021-9042	021-9043	021-9044	021-9045	021-9046	021-9047	021-9048



LANYARDS

Cable or web, single or dual leg, internal or external energy absorber— these are just a few questions to ask when choosing the best lanyard for the job. With nearly a dozen lanyard categories, our experts can help you quickly select the right one to keep your team moving safe onsite.



**INTERESTED IN THE NEWEST
RELEASES FOR LANYARDS?**
Scan this code to view them now!



PRO

These lanyards utilize external tear webbing for deceleration and force management. Built with premium materials including forged hooks and ballistic polyester shock pack covers with integrated protective label cover.



PRO STRETCH INTERNAL

These lanyards use a specially woven webbing of POY and elasticized yarns. This allows the lanyard to stretch while still providing required ANSI deceleration and force management necessary in a fall event. Equipped with forged steel and aluminum hooks.



PRO INTERNAL

These lanyards use specially woven webbing with POY as the core, which acts as the deceleration and force management system. Equipped with forged hooks and durable label covers.



PRO STRETCH

These lanyards use an external tear webbing with shock cover combined with elasticated webbing lanyard legs. This allows the webbing to contract when not in use reducing trip or snag hazards. Offered with forged steel and aluminum hooks.



V-LINE

Our economical external tear webbing lanyards built with a durable shock pack cover with integrated protective label cover and stamped steel hooks.



V-LINE STRETCH INTERNAL

Our economical stretch internal lanyards use tubular webbing and a POY/elastic filled core. Equipped with a protective label cover and stamped steel hooks.



V-LINE INTERNAL

Our economical internal construction lanyards. Built with tubular webbing and a POY filled core. Equipped with a protective label cover and stamped steel hooks.



LEADING EDGE

The one solution for all. Versatile leading edge cable lanyard offering fall protection for users 130-310 lbs. (ANSI) and up to 420 lbs. (OSHA). Meets the requirements for 6' and 12' freefall as well as leading edge for both.



ARC FLASH

This is a highly specialized lanyard solution. Built with the best materials, these products provide the safety and security necessary when working at height in arc event rated areas.



WELDING

Engineered for tough environments specific to workers exposed to flame, fire or other welding processes. These lanyards are built with premium aramid webbing and materials.



SPECIALTY

Lanyard solutions for specialized applications including heavy duty use, restraint for fall prevention, work positioning assemblies and D-ring extenders for quick attachment and release.

PRO ENERGY ABSORBING LANYARD

- UV and abrasion resistant 1" polyester webbing
- Protective ballistic shock and label cover
- Forged steel hooks



FS566
FS566-4

FS566	PRO 6' Energy Absorbing Lanyard: Dual Leg, Rebar Hook	6'	Dual
FS566-4	PRO 4' Energy Absorbing Lanyard: Dual Leg, Rebar Hook	4'	Dual
FS565	PRO 6' Energy Absorbing Lanyard: Rebar Hook	6'	Single
FS561	PRO 6' Energy Absorbing Lanyard: Dual Leg, Snap Hooks	6'	Dual
FS560	PRO 6' Energy Absorbing Lanyard: Snap Hook	6'	Single
FS560-4	PRO 4' Energy Absorbing Lanyard: Snap Hook	4'	Single
FS560-3	PRO 3' Energy Absorbing Lanyard: Snap Hook	3'	Single
FS560-SE	PRO 6' Energy Absorbing Lanyard: Soft Loop	6'	Single



FS565



FS561



FS560



FS560-4



FS560-3



FS560-SE

PRO 4'-6' ADJUSTABLE ENERGY ABSORBING LANYARD

- Versatile adjustability from 4'-6'
- UV and abrasion resistant 1" polyester webbing
- Protective ballistic shock and label cover
- Forged steel hooks



FS560-SE-AJ

FS560-SE-AJ	PRO 4'-6' Adjustable Energy Absorbing Lanyard: Soft Loop	Single
FS566-AJ	PRO 4'-6' Adjustable Energy Absorbing Lanyard: Dual Leg, Rebar Hooks	Dual
FS565-AJ	PRO 4'-6' Adjustable Energy Absorbing Lanyard: Rebar Hook	Single
FS561-AJ	PRO 4'-6' Adjustable Energy Absorbing Lanyard: Dual Leg, Snap Hooks	Dual
FS560-AJ	PRO 4'-6' Adjustable Energy Absorbing Lanyard: Snap Hook	Single



FS566-AJ

FS565-AJ

FS561-AJ

FS560-AJ

PRO 6' TIE-BACK ENERGY ABSORBING LANYARD

- UV and abrasion resistant 1" polyester webbing
- Protective ballistic shock and label cover
- Forged steel hooks



FS456	PRO 6' Tie-Back Energy Absorbing Lanyard: Dual Leg, Adjustable Ring	Dual
FS455	PRO 6' Tie-Back Energy Absorbing Lanyard: Adjustable Ring	Single
FS451	PRO 6' Tie-Back Energy Absorbing Lanyard: Dual Leg	Dual
FS450	PRO 6' Tie-Back Energy Absorbing Lanyard	Single

PRO 6' CABLE ENERGY ABSORBING LANYARD

- Abrasion resistant 5/16" coated cable
- Protective ballistic shock and label cover
- Forged steel hooks

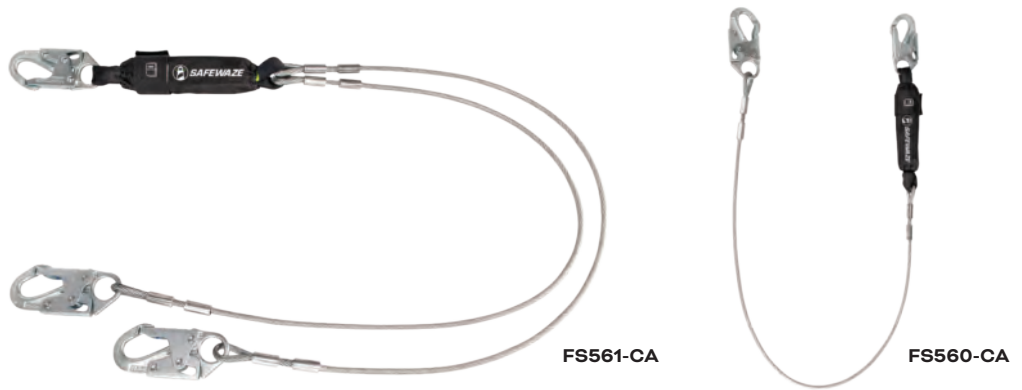

FS561-CA	PRO 6' Cable Energy Absorbing Lanyard: Dual Leg, Snap Hooks	Dual
FS560-CA	PRO 6' Cable Energy Absorbing Lanyard: Snap Hook	Single

PRO 6' ROPE ENERGY ABSORBING LANYARD

- UV and abrasion resistant 5/8" polyester rope
- Protective ballistic shock and label cover
- Forged steel hooks



FS33216	PRO 6' Rope Energy Absorbing Lanyard: Dual Leg, Snap Hooks	Dual
FS33215	PRO 6' Rope Energy Absorbing Lanyard: Snap Hook	Single

PRO 6' STRETCH INTERNAL ENERGY ABSORBING LANYARD

- Stretches from 4' to 6' to reduce trip and snag hazards
- 1-3/8" elasticized poly/POY webbing
- Protective label cover
- Forged steel or aluminum hooks



FS596-ALU

FS596-ALU	PRO 6' Stretch Internal Energy Absorbing Lanyard: Dual Leg, Alu Rebar Hooks	Dual
FS596	PRO 6' Stretch Internal Energy Absorbing Lanyard: Dual Leg, Rebar Hooks	Dual
FS595-ALU	PRO 6' Stretch Internal Energy Absorbing Lanyard: Alu Rebar Hook	Single
FS595	PRO 6' Stretch Internal Energy Absorbing Lanyard: Rebar Hook	Single
FS66150-ALU	PRO 6' Stretch Internal Energy Absorbing Lanyard: Dual Leg, O-Ring, Alu Rebar Hooks	Dual
FS66150	PRO 6' Stretch Internal Energy Absorbing Lanyard: Dual Leg, O-Ring, Rebar Hooks	Dual
FS66100	PRO 6' Stretch Internal Energy Absorbing Lanyard: O-Ring, Rebar Hook	Single
FS591-ALU	PRO 6' Stretch Internal Energy Absorbing Lanyard: Dual Leg, Alu Snap Hooks	Dual
FS591	PRO 6' Stretch Internal Energy Absorbing Lanyard: Dual Leg, Snap Hooks	Dual
FS590-ALU	PRO 6' Stretch Internal Energy Absorbing Lanyard: Alu Snap Hook	Single
FS590	PRO 6' Stretch Internal Energy Absorbing Lanyard: Snap Hook	Single



FS596



FS595-ALU



FS595



FS66150-ALU



FS66150



FS66100



FS591-ALU



FS591



FS590-ALU



FS590

PRO 6' STRETCH ENERGY ABSORBING LANYARD: 12' FF

- 12' free fall lanyard
- Stretches from 4' to 6' to reduce trip and snag hazards
- Protective ballistic shock and label cover
- Forged steel or aluminum hooks



FS88761-FF-ALU

FS88761-FF-ALU	PRO 6' Stretch Energy Absorbing Lanyard: 12' FF, Dual Leg, Alu Rebar Hooks, Rescue Rings	Dual
FS88761-FF-RB-AL	PRO 6' Stretch Energy Absorbing Lanyard: 12' FF, Dual Leg, Alu Rebar Hooks	Dual
FS88761-FF	PRO 6' Stretch Energy Absorbing Lanyard: 12' FF, Dual Leg, Snap Hooks	Dual
FS88760-FF	PRO 6' Stretch Energy Absorbing Lanyard: 12' FF, Snap Hook	Single

PRO 6' Stretch Energy Absorbing Lanyards: 12' FF



FS88761-FF-RB-AL

FS88761-FF

FS88760-FF

PRO 6' Stretch Energy Absorbing Lanyards



FS575

FS571

FS570

FS578

PRO 6' STRETCH ENERGY ABSORBING LANYARD

- Stretches from 4' to 6' to reduce trip and snag hazards
- Protective ballistic shock and label cover
- Forged steel hooks



FS576

FS576	PRO 6' Stretch Energy Absorbing Lanyard: Dual Leg, Rebar Hooks	Dual
FS575	PRO 6' Stretch Energy Absorbing Lanyard: Rebar Hook	Single
FS571	PRO 6' Stretch Energy Absorbing Lanyard: Dual Leg, Snap Hooks	Dual
FS570	PRO 6' Stretch Energy Absorbing Lanyard: Snap Hook	Single
FS578	PRO 6' Stretch Energy Absorbing Lanyard: Rebar Hooks, Rescue Rings	Dual

PRO 6' INTERNAL ENERGY ABSORBING LANYARD

- 1-3/8" poly/POY webbing
- Protective label cover
- Forged steel hooks



FS580

FS580	PRO 6' Internal Energy Absorbing Lanyard: Snap Hook	Single
FS581	PRO 6' Internal Energy Absorbing Lanyard: Dual Leg, Snap Hooks	Dual
FS585	PRO 6' Internal Energy Absorbing Lanyard: Rebar Hook	Single
FS586	PRO 6' Internal Energy Absorbing Lanyard: Dual Leg, Rebar Hooks	Dual



FS581

FS585

FS586

V-LINE ENERGY ABSORBING LANYARD

- Abrasion resistant 1" polyester webbing
- Protective ballistic shock and label cover
- Stamped steel hooks



FS88566-E

FS88566-E	V-Line 6' Energy Absorbing Lanyard: Dual Leg, Rebar Hooks	6'	Dual
FS88565-E	V-Line 6' Energy Absorbing Lanyard: Rebar Hook	6'	Single
FS88561-E	V-Line 6' Energy Absorbing Lanyard: Dual Leg, Snap Hooks	6'	Dual
FS88560-E	V-Line 6' Energy Absorbing Lanyard: Snap Hook	6'	Single
FS88560-E3	V-Line 3' Energy Absorbing Lanyard: Snap Hook	3'	Single



FS88565-E

FS88561-E

FS88560-E

FS88560-E3

V-LINE 6' STRETCH INTERNAL ENERGY ABSORBING LANYARD

- Stretches from 4' to 6' to reduce trip and snag hazards
- 1-3/8" tubular poly webbing
- Protective label cover
- Stamped steel hooks



FS88596

FS88596	V-Line 6' Stretch Internal Energy Absorbing Lanyard: Dual Leg, Rebar Hooks	Dual
FS88595	V-Line 6' Stretch Internal Energy Absorbing Lanyard: Rebar Hook	Single
FS88591	V-Line 6' Stretch Internal Energy Absorbing Lanyard: Dual Leg, Snap Hooks	Dual
FS88590	V-Line 6' Stretch Internal Energy Absorbing Lanyard: Snap Hook	Single

V-Line 6' Stretch Internal Energy Absorbing Lanyard



FS88595

FS88591

FS88590

V-Line 6' Internal Energy Absorbing Lanyard



FS88585

FS88581

FS88580

V-LINE 6' INTERNAL ENERGY ABSORBING LANYARD

- 1-3/8" tubular poly webbing
- Protective label cover
- Stamped steel hooks



FS88586

FS88586	V-Line 6' Internal Energy Absorbing Lanyard: Dual Leg, Rebar Hooks	Dual
FS88585	V-Line 6' Internal Energy Absorbing Lanyard: Rebar Hook	Single
FS88581	V-Line 6' Internal Energy Absorbing Lanyard: Dual Leg, Snap Hooks	Dual
FS88580	V-Line 6' Internal Energy Absorbing Lanyard: Snap Hook	Single

LEADING EDGE 6' ENERGY ABSORBING LANYARD

- Versatile as both 6' and 12' free fall lanyard
- 1/4" hi-vis coated green aircraft grade cable
- Protective ballistic shock and label cover
- Forged steel or aluminum hooks

The closest you can get to an all-purpose lanyard



019-2011

019-2011	Leading Edge 6' Energy Absorbing Lanyard: Snap Hook	Single
019-2012	Leading Edge 6' Energy Absorbing Lanyard: Dual Leg, Snap Hooks	Dual
019-2013	Leading Edge 6' Energy Absorbing Lanyard: Rebar Hook	Single
019-2014	Leading Edge 6' Energy Absorbing Lanyard: Dual Leg, Rebar Hooks	Dual
019-2015	Leading Edge 6' Energy Absorbing Lanyard: Dual Leg, Alu Swivel Snap Hooks	Dual
019-2016	Leading Edge 6' Energy Absorbing Lanyard: Dual Leg, Alu Swivel Rebar Hooks	Dual
021-2062	Leading Edge 6' Energy Absorbing Lanyard: Dual Leg, D-Ring, Snap Hooks	Dual



019-2012



019-2013



019-2014



019-2015



019-2016



021-2062

ARC FLASH 6' ENERGY ABSORBING LANYARD

- Flame and heat resistant 1-3/4" aramid webbing
- Premium Nomex® shock and label cover
- Dielectric, forged steel or aluminum hooks
- 40Cal/750F char rated



020-2040

020-2040	Arc Flash 6' Energy Absorbing Lanyard: Aramid, Dual Leg, Dielectric Snap Hooks	Dual
020-2041	Arc Flash 6' Energy Absorbing Lanyard: Aramid, Dual Leg, Alu Rebar Hooks	Dual
020-2042	Arc Flash 6' Energy Absorbing Lanyard: Aramid, Dual Leg, Rebar Hooks	Dual
020-2043	Arc Flash 6' Energy Absorbing Lanyard: Aramid, Dual Leg, Alu Snap Hooks	Dual
020-2044	Arc Flash 6' Energy Absorbing Lanyard: Aramid, Dual Leg, Snap Hooks	Dual
020-2045	Arc Flash 6' Energy Absorbing Lanyard: Aramid, Snap Hook	Single
020-2046	Arc Flash 6' Energy Absorbing Lanyard: Aramid, Snap Hook, Soft Loop	Single
022-2087	Arc Flash 6' Energy Absorbing Lanyard: Aramid, Dielectric Snap Hook, Soft Loop	Single



020-2041



020-2042



020-2043



020-2044



020-2045



020-2046



022-2087

023-2098 / ARC FLASH 6' ENERGY ABSORBING LANYARD: 12'FF, Aramid, Dual Leg, Tower Rebar Hook

- 12' free fall lanyard
- Flame and heat resistant 1-3/4" aramid webbing
- Forged steel snap hook
- Large stamped steel tower rebar hooks
- Premium Nomex® shock and label cover
- 40Cal/750F char rated



ARC FLASH 6' ENERGY ABSORBING LANYARD

- Flame and heat resistant 1" nylon webbing
- Premium Nomex® shock and label cover
- Dielectric or forged steel hooks
- 40Cal/550F char rated



SW561-AF-DE	Arc Flash 6' Energy Absorbing Lanyard: Dual Leg, Dielectric Snap Hooks	Dual
SW560-AF-DE	Arc Flash 6' Energy Absorbing Lanyard: Dielectric Snap Hook	Single
SW560-AF-DE-SE	Arc Flash 6' Energy Absorbing Lanyard: Dielectric Snap Hook, Soft Loop	Single
FS560-AF-SE	Arc Flash 6' Energy Absorbing Lanyard: Snap Hook, Soft Loop	Single
FS560-AF	Arc Flash 6' Energy Absorbing Lanyard: Snap Hook	Single



SW560-AF-DE SW560-AF-DE-SE FS560-AF-SE FS560-AF

ARC FLASH 4'-6' ADJUSTABLE ENERGY ABSORBING LANYARD

- Versatile adjustability from 4'-6'
- Flame and heat resistant 1" nylon webbing
- Premium Nomex® label and shock cover
- Forged steel hooks
- 40Cal/550F char rated



FS560-AF-AJ	Arc Flash 4'-6' Adjustable Energy Absorbing Lanyard: Snap Hook	Single
FS560-AF-SE-AJ	Arc Flash 4'-6' Adjustable Energy Absorbing Lanyard: Snap Hook, Soft Loop	Single

ARC FLASH 4'-6' ADJUSTABLE WEB RESTRAINT LANYARD

- Versatile adjustability from 4'-6'
- Premium Nomex® label cover
- For positioning and restraint use



025-2167
Flame and heat resistant 1-3/4" aramid webbing
40Cal/750F char rated



023-2100
• Flame and heat resistant 1" nylon webbing
• 40Cal/550F char rated

025-2167	Arc Flash 4'-6' Adjustable Web Restraint Lanyard: Aramid, DE Snap Hooks	Single
023-2100	Arc Flash 4'-6' Adjustable Web Restraint Lanyard: Snap Hooks	Single

ARC FLASH 6' STRETCH INTERNAL ENERGY ABSORBING LANYARD

- Innovative aramid webbing with internal POY for energy absorption
- Stretches from 4.5'-6' to reduce trip hazard
- Dielectric, forged steel or aluminum hooks
- Premium Nomex® label cover
- 40Cal/750F char rateds



023-2115

023-2115	Arc Flash 6' Stretch Internal Energy Absorbing Lanyard: Aramid, Dual Leg, Snap Hooks	Dual
023-2116	Arc Flash 6' Stretch Internal Energy Absorbing Lanyard: Aramid, Dual Leg, Rebar Hooks	Dual
023-2117	Arc Flash 6' Stretch Internal Energy Absorbing Lanyard: Aramid, Dual Leg, Alu Snap Hooks	Dual
023-2118	Arc Flash 6' Stretch Internal Energy Absorbing Lanyard: Aramid, Dual Leg, Alu Rebar Hooks	Dual
023-2119	Arc Flash 6' Stretch Internal Energy Absorbing Lanyard: Aramid, Dual Leg, DE Snap Hooks	Dual
023-2120	Arc Flash 6' Stretch Internal Energy Absorbing Lanyard: Aramid, Snap Hook	Single
023-2121	Arc Flash 6' Stretch Internal Energy Absorbing Lanyard: Aramid, Rebar Hook	Single
023-2122	Arc Flash 6' Stretch Internal Energy Absorbing Lanyard: Aramid, Alu Snap Hook	Single
023-2123	Arc Flash 6' Stretch Internal Energy Absorbing Lanyard: Aramid, Alu Rebar Hook	Single
023-2124	Arc Flash 6' Stretch Internal Energy Absorbing Lanyard: Aramid, DE Snap Hook	Single



023-2116



023-2117



023-2118



023-2119



023-2120



023-2121



023-2122



023-2123



023-2124

ARC FLASH 6' INTERNAL ENERGY ABSORBING LANYARD

- High performance 1-3/8" tubular aramid webbing
- Dielectric, forged steel or aluminum hooks
- Premium Nomex® label cover
- 40Cal/750F char rated



023-2101

023-2101	Arc Flash 6' Internal Energy Absorbing Lanyard: Aramid, Dual Leg, Snap Hooks	Dual
023-2102	Arc Flash 6' Internal Energy Absorbing Lanyard: Aramid, Dual Leg, Rebar Hooks	Dual
023-2103	Arc Flash 6' Internal Energy Absorbing Lanyard: Aramid, Dual Leg, Alu Snap Hooks	Dual
023-2104	Arc Flash 6' Internal Energy Absorbing Lanyard: Aramid, Dual Leg, Alu Rebar Hooks	Dual
023-2105	Arc Flash 6' Internal Energy Absorbing Lanyard: Aramid, Dual Leg, Dielectric Snap Hooks	Dual
023-2107	Arc Flash 6' Internal Energy Absorbing Lanyard: Aramid, Snap Hook	Single
023-2108	Arc Flash 6' Internal Energy Absorbing Lanyard: Aramid, Rebar Hook	Single
023-2109	Arc Flash 6' Internal Energy Absorbing Lanyard: Aramid, Alu Snap Hook	Single
023-2110	Arc Flash 6' Internal Energy Absorbing Lanyard: Aramid, Alu Rebar Hook	Single
023-2111	Arc Flash 6' Internal Energy Absorbing Lanyard: Aramid, Dielectric Snap Hook	Single



023-2102



023-2103



023-2104



023-2105



023-2107



023-2108



023-2109



023-2110



023-2111

ARC FLASH 6' INTERNAL ENERGY ABSORBING LANYARD

- High performance 1-3/8" tubular aramid webbing
- Aramid soft loop connection
- Dielectric, forged steel or aluminum hooks
- Premium Nomex® label cover
- 40Cal/750F rated



024-2150

024-2150	Arc Flash 6' Internal Energy Absorbing Lanyard: Aramid, Soft Loop, Snap Hook	Single
024-2151	Arc Flash 6' Internal Energy Absorbing Lanyard: Aramid, Dual Leg, Soft Loop, Snap Hooks	Dual
024-2152	Arc Flash 6' Internal Energy Absorbing Lanyard: Aramid, Soft Loop, Rebar Hook	Single
024-2153	Arc Flash 6' Internal Energy Absorbing Lanyard: Aramid, Dual Leg, Soft Loop, Rebar Hooks	Dual
024-2154	Arc Flash 6' Internal Energy Absorbing Lanyard: Aramid, Soft Loop, Alu Snap Hook	Single
024-2155	Arc Flash 6' Internal Energy Absorbing Lanyard: Aramid, Dual Leg, Soft Loop, Alu Snap Hooks	Dual
024-2156	Arc Flash 6' Internal Energy Absorbing Lanyard: Aramid, Soft Loop, Alu Rebar Hook	Single
024-2157	Arc Flash 6' Internal Energy Absorbing Lanyard: Aramid, Dual Leg, Soft Loop, Alu Rebar Hooks	Dual
024-2158	Arc Flash 6' Internal Energy Absorbing Lanyard: Aramid, Soft Loop, Dielectric Snap Hook	Single
024-2159	Arc Flash 6' Internal Energy Absorbing Lanyard: Aramid, Dual Leg, Soft Loop, Dielectric Snap Hooks	Dual



024-2151



024-2152



024-2153



024-2154



024-2155



024-2156



024-2157



024-2158



024-2159

WELDING 6' ENERGY ABSORBING LANYARD

- Protective 1-3/4" aramid webbing
- Forged steel hooks
- Premium Nomex® shock and label cover
- 40Cal/750F rated



FS77330-FR-DL



FS77330-FR

FS77330-FR-DL	Welding 6' Energy Absorbing Lanyard: Dual Leg, Snap Hooks	Dual
FS77330-FR	Welding 6' Energy Absorbing Lanyard: Snap Hook	Single

WELDING 6' ENERGY ABSORBING LANYARD

- Protective 1-3/4" dual layer aramid webbing
- Forged steel hooks
- Premium Nomex® shock and label cover
- 40Cal/700F rated



FS77435-WE-DL

FS77435-WE-DL	Welding 6' Energy Absorbing Lanyard: Dual Leg, Rebar Hooks	Dual
FS77435-WE	Welding 6' Energy Absorbing Lanyard: Rebar Hook	Single
FS77430-WE-DL	Welding 6' Energy Absorbing Lanyard: Dual Leg, Snap Hooks	Dual
FS77430-WE	Welding 6' Energy Absorbing Lanyard: Snap Hooks	Single



FS77435-WE



FS77430-WE-DL



FS77430-WE

PRO-SHIELD 6' ENERGY ABSORBING LANYARD

- Special polyurethane coated webbing for long-lasting protection
- Water, chemical, UV and abrasion resistant
- Ideal for painters and window washers
- Forged steel or aluminum hooks
- Rubberized, water repellent shock and label cover



024-2136

024-2136	PRO-Shield 6' Energy Absorbing Lanyard: Snap Hook	Single
024-2137	PRO-Shield 6' Energy Absorbing Lanyard: Alu Snap Hook	Single
024-2138	PRO-Shield 6' Energy Absorbing Lanyard: Rebar Hook	Single
024-2139	PRO-Shield 6' Energy Absorbing Lanyard: Alu Rebar Hook	Single
024-2140	PRO-Shield 6' Energy Absorbing Lanyard: Dual Leg, Snap Hooks	Dual
024-2141	PRO-Shield 6' Energy Absorbing Lanyard: Dual Leg, Alu Snap Hooks	Dual
024-2142	PRO-Shield 6' Energy Absorbing Lanyard: Dual Leg, Rebar Hooks	Dual
024-2143	PRO-Shield 6' Energy Absorbing Lanyard: Dual Leg, Alu Rebar Hooks	Dual



024-2137



024-2138



024-2139



024-2140



024-2141



024-2142



024-2143

HEAVYWEIGHT 6' ENERGY ABSORBING LANYARD

- For workers from 310-420 lbs.
- High-strength 1" webbing
- Protective ballistic shock and label cover
- Forged steel or aluminum hooks



FS88666-HW-ALU

FS88666-HW-ALU	Heavyweight 6' Energy Absorbing Lanyard: Dual Leg, Alu Rebar Hooks	Dual
FS88666-HW	Heavyweight 6' Energy Absorbing Lanyard: Dual Leg, Rebar Hooks	Dual
FS88665-HW	Heavyweight 6' Energy Absorbing Lanyard: Rebar Hook	Single
FS88661-HW	Heavyweight 6' Energy Absorbing Lanyard: Dual Leg, Snap Hooks	Dual
FS88660-HW	Heavyweight 6' Energy Absorbing Lanyard: Snap Hook	Single



FS88666-HW



FS88665-HW



FS88661-HW



FS88660-HW

FALL ARREST



Fall arrest system is fall protection designed to safely stop a person who has already fallen. This system includes a harness, connecting device with an energy-absorber such as a lanyard or SRL and anchorage. These systems are critical where a risk of falling from an elevated height exists and the hazard cannot be eliminated.



FALL RESTRAINT



Fall restraint means to hold back a worker so they cannot fall. A fall restraint system, also known as a travel restraint system, is fall protection designed to prevent a worker from reaching a fall hazard. This system includes a harness, restraint lanyard without an energy absorber and anchorage.



POSITIONING



Positioning system is fall protection designed to keep a worker in a fixed position at height so they can more easily perform work with their hands. A positioning system is also often used with a fall arrest system.

WEB RESTRAINT LANYARD

- 1" hi-vis webbing
- Forged steel hooks
- For positioning and restraint use



FS88860-3
FS88860-4
FS88860



FS33310

- Versatile adjustability from 4'-6'

FS88860-3	3' Web Restraint Lanyard	3'
FS88860-4	4' Web Restraint Lanyard	4'
FS88860	6' Web Restraint Lanyard	6'
FS33310	6' Adjustable Web Restraint Lanyard	4'-6'

FS33210 / 6' ROPE RESTRAINT LANYARD

- Abrasion resistant 5/8" polyester rope
- Forged steel hooks
- For positioning and restraint use



021-2075 / 20' WEB RESTRAINT: Alu Snap Hook, Alu Rebar Hook

- 1-3/4" webbing
- Aluminum hooks
- For positioning and restraint use



023-2135 / 26"-48" ADJUSTABLE WEB RESTRAINT ASSEMBLY

- Required in MEWPs in motion (bucket trucks, aerial lifts)
- 1" hi-vis webbing
- Steel hooks with swivel for easy anchoring
- For positioning and restraint use

**FS33200 / 6' ROPE POSITIONING ASSEMBLY: Rope Ascender, Snap Hook**

- 5/8" polyester rope with rope protector
- Forged steel hook and grab
- For positioning and restraint use

**6.5' ROPE POSITIONING ASSEMBLY**

- Durable 7/16" Kernmantle rope
- Easy positioning rope adjuster
- Protective nylon wear sleeve
- Aluminum or steel carabiners
- For positioning and restraint use



021-2064

021-2064	6.5' Rope Positioning Assembly: Rope Adjuster, Carabiners
021-2065	6.5' Rope Positioning Assembly: Rope Adjuster, Alu Carabiners
021-2066	6.5' Rope Positioning Assembly: Rope Adjuster, No connectors



021-2065

021-2066

CHAIN ASSEMBLY

- Ideal for positioning on rebar and concrete structures
- Heavy duty, long-lasting chain
- Forged or stamped steel hooks
- Rebar hook options for swivel and gates form



FS060

FS060	26" Chain Assembly: Adjustable, Swivel Rebar Hook	26"
FS060-E	26" Chain Assembly: Adjustable, Non-Swivel Rebar Hook	26"
FS061	19" Chain Assembly: Swivel Rebar Hook	19"



FS060-E



FS061

18" WEB ASSEMBLY

- Ideal for positioning on rebar and concrete structures
- Flexible polyester webbing
- Forged steel hooks



FS060-WEB



FS060-WEB-SH

FS060-WEB	18" Web Assembly: Swivel Rebar Hook
FS060-WEB-SH	18" Web Assembly: Snap Hook

CHOOSING THE RIGHT LANYARD

In a personal fall arrest system (PFAS), a lanyard connects your harness to an anchor point or to a horizontal or vertical lifeline, which acts as an intermediate connection to the anchor.

While lanyards are typically 6' in length, shorter and longer options are available. Always select the shortest possible lanyard. Lanyards should be long enough to allow adequate job site work without creating undue free fall distance.

Even a minimal fall can create tremendous force. For example, a 200 lb. worker falling 10 feet is subject to 8,000 lbs. of force in an abrupt dynamic drop. A properly selected and installed PFAS lanyard can drastically reduce the force to below 1,800 lbs., preventing serious injury.

When selecting the best lanyard for the job, ask:

- » What is the fall clearance to the next level?
- » Where is the anchor point located, above or below the harness D-ring?
- » Will you plan for fall arrest or eliminate the hazard by using a positioning lanyard?
- » Will you be working near or over what ANSI defines as a leading edge?
- » What is the right material for your lanyard based on the environment?
- » What lanyard connectors do I need to properly tie off?



LANYARD TYPES

- » **Energy Absorbing Lanyards** – Built with an external or internal energy absorption system engineered to arrest the user and reduce the forces inflicted upon the body in a fall event.
- » **Positioning Lanyards** – Built without an energy absorption system and used mainly for positioning or restraint situations that eliminate the likelihood of a fall event.



LANYARD CONSTRUCTIONS

- » **6' Free Fall** – For use at or above the dorsal D-ring to prevent a free fall greater than 6 feet.
- » **12' Free Fall** – For use in foot level anchorage applications with a specialized absorber to handle the 12 foot free fall.
- » **Single Leg** – One connection point for simplicity and weight reduction.
- » **Dual Leg** – Two connection points for continuous attachment to an anchor.



LANYARD MATERIALS

- » **Webbing** – The flexible and dependable choice for most applications.
- » **Rope** – For increased abrasion resistance and strength.
- » **Cable** – Ideal for high heat or leading edge environments.
- » **Specialty** – Coated webbing for protection against grease, oil, or other contaminants.
- » **Aramid** – Webbing for fire, welding, or arc flash conditions.



CONNECTOR

- » **Soft Loop** – Chokes the lanyard harness attachment point.
- » **Snap Hook** – The most common option for small anchor points.
- » **Carabiner** – A twist lock gate alternative to hooks.
- » **Scaffolding/Rebar Hook** – Offers a larger gate opening for a variety of structural connections.
- » **Tie-Back Hook** – Specially built for applications where a standard anchor or connection is unavailable.

18" D-RING EXTENDER

- Fixed length with quick, easy connection
- Forged steel hardware



FS813

FS813	18" D-ring Extender: Snap Hook, D-ring
FS813-2D	18" D-ring Extender: Snap Hook, 2 D-rings



FS813-2D

18" D-RING EXTENDER

- Fixed length with quick, easy connection
- Soft choke loop for versatility



FS813-LOOP

FS813-LOOP	18" D-ring Extender: Soft Loop, D-ring
019-2008	18" D-ring Extender: Soft Loop, 2 D-rings



019-2008

ARC FLASH D-RING EXTENDER

- Fixed length with easy connection
- Aramid soft choke loop for versatility
- Forged steel hardware
- Protective Nomex® label cover
- 40Cal char rated



022-2080

022-2080	12" Arc Flash D-Ring Extender: Soft Loop, D-ring
022-2081	18" Arc Flash D-Ring Extender: Soft Loop, D-ring



022-2081

023-2113 / **PRO-SHIELD 18" D-RING EXTENDER:** Snap Hook, D-ring

- Special polyurethane coated webbing for long-lasting protection
- Water, chemical, UV and abrasion resistant
- Ideal for painters and window washers
- Forged steel hardware



FALL CLEARANCE - LANYARDS

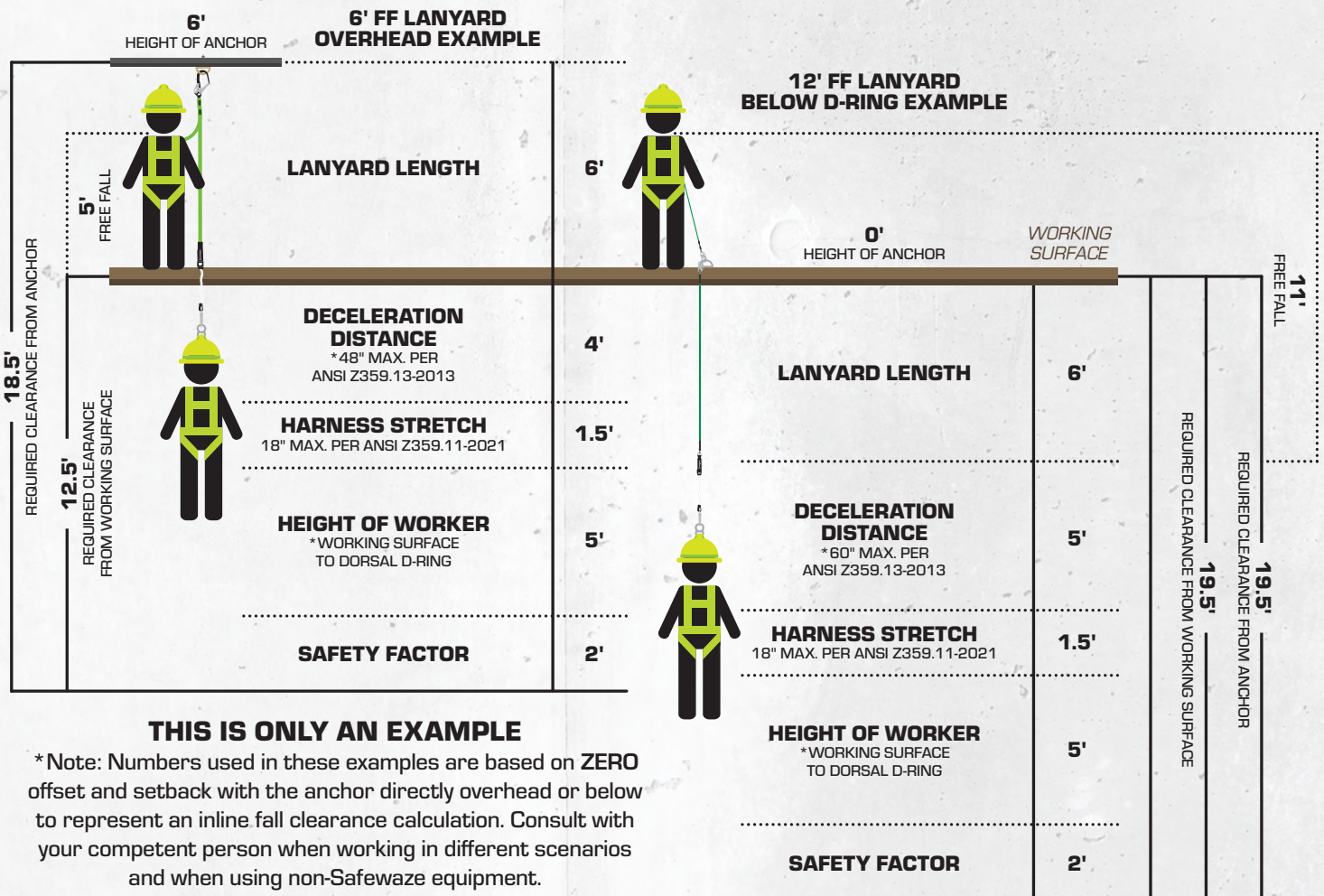

WARNING!

*ELIMINATE SWING FALL BY WORKING AS CLOSE TO AND INLINE TO THE ANCHORAGE AS POSSIBLE

NOTE: DO NOT EXCEED 4' SWING FALL DROP DISTANCE PER ANSI Z359.6-2016



SELF-RETRACTING LIFELINES

You can have it all with our self-retracting lifelines: enhanced mobility, increased durability and continued dependability. From lightweight or heavy-duty to edge or arc flash, with advanced options such as a revolutionary internal braking system, our SRLs are proven to go the distance.



NORTHSTAR

This exclusive line of SRLs is engineered for enhanced productivity with superior design, durability, features and functionality. Including options for sharp edge and coastal environments, this is the most advanced offering in the SRL category.



NORTHSTAR CLASSIC

The dependable workhorse with an outstanding track record of reliability. Built to last, this line provides an economical solution without compromising performance, convenience or safety.



INTERESTED IN THE NEWEST
RELEASES FOR SRLS?

Scan this code to view them now!



LODESTAR

Includes SRLs designed to reduce nuisance lock-ups as well as SRLs for use in lifts. Featuring a robust housing, swivel top and fast-acting braking system, these units ensure optimal functionality while prioritizing worker safety.



LATITUDE PRO

The performance driven personal SRL series that utilizes a revolutionary internal brake system to reduce work zone obstructions. Built to provide the end user with the certainty and confidence they need to work in a wide variety of jobsite conditions, including tie-back options.



LATITUDE HD

The versatile overhead and personal SRL series. Built with a durable aluminum housing and internal brake system. When the job calls for "heavy-duty" these are the units you can count on.



ACCESSORIES

Durable components designed to enhance SRL performance including installation brackets, tagline rope and mounting brackets for secure anchoring in lifts.



LATITUDE EDGE

The personal SRL solution for edge applications. These units are specifically designed for foot level tie-off and allow the worker-at-height to access locations other web or non-LE units can't take them.



LATITUDE

The extremely compact and lightweight personal SRL with a design that is virtually unnoticeable on the body. This is the simple and economical replacement to a traditional lanyard offering versatility and additional safety.



ARC FLASH

A comprehensive line of SRLs with added protection for premium performance in extreme environments such as arc flash, hot works and welding.

NORTHSTAR
EDGE

- Increased durability with glass-filled nylon housing
- Maximum dependability from oscillating, double-locking, anti-ratcheting pawls
- Simplified service system keeps SRL in the field longer
- Ergonomic carrying handle for comfortable grip
- 360°/180° attachment point swivels for full range of motion
- Smoother retraction with side payout
- RFID equipped for easy asset tracking
- Steel carabiner attachment
- Steel swivel snap hook
- Galvanized steel cable

CLASS 2
Anchor above or below dorsal D-ring



022-5301

022-5300	20' Cable SRL
022-5301	30' Cable SRL
022-5302	50' Cable SRL

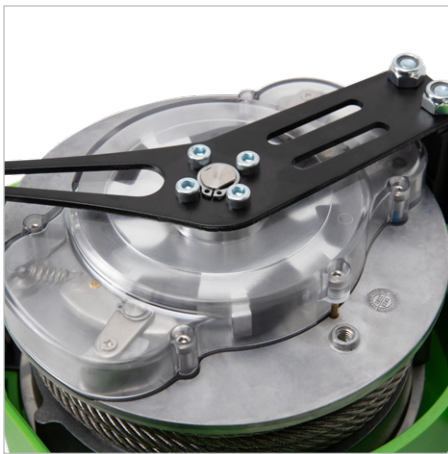

Longer product life with semi-sealed mainspring and pawl assembly



Compact energy absorber protected in durable pack with label cover



Proprietary cable retraction limiter eliminates dangerous freewheeling



- All the Northstar Edge features with added corrosion resistance
- Ideal for extreme environments with salt water or high humidity
- Aluminum carabiner attachment
- Load-indicating stainless steel swivel snap hook
- Stainless steel cable

022-5292	20' SS Cable SRL
022-5293	30' SS Cable SRL
022-5294	50' SS Cable SRL



CLASS 2
Anchor above or below dorsal D-ring



022-5292

NORTHSTAR
CLASSIC

- Swivel attachment point offers wide range of motion
- High-strength polymer housing resists impact
- Braking system activates quickly to arrest fall
- Steel carabiner attachment
- UHMPE heavy-duty webbing with fall indicator

FS-FSP1420-W	20' Web SRL	Steel snap hook
024-5396	30' Web SRL	Load-indicating steel swivel snap hook
024-5397	50' Web SRL	



FS-FSP1420-W



024-5396

CLASS 1
Anchor at or above dorsal D-ring

NORTHSTAR
CLASSIC LE



CLASS 2
Anchor above or below dorsal D-ring

- External energy absorber for edge use
- Swivel attachment point offers wide range of motion
- High-strength polymer housing resists impact
- Braking system activates quickly to arrest fall
- Steel carabiner attachment
- Aluminum swivel carabiner
- Galvanized steel cable

FS-FSP9020	20' Cable SRL
FS-FSP9030	30' Cable SRL
FS-FSP9050	50' Cable SRL

FS-FSP9020

FS-FSP9030

FS-FSP9050



FS-FSP1220-G

FS-FSP1230-G

FS-FSP1250-G

FS-FSP1265-G

FS-EX1080-G

- Swivel attachment point offers wide range of motion
- High-strength polymer housing resists impact
- Braking system activates quickly to arrest fall
- Steel carabiner attachment
- Options for galvanized or stainless steel cable
- Load-indicating steel swivel snap hook

Galvanized Steel Cable

FS-FSP1215-G	15' Cable SRL
FS-FSP1220-G	20' Cable SRL
FS-FSP1230-G	30' Cable SRL
FS-FSP1250-G	50' Cable SRL
FS-FSP1265-G	65' Cable SRL
FS-EX1080-G	80' Cable SRL
FS-EX10-100-G	100' Cable SRL

Stainless Steel Cable

FS-FSP1215-SS	15' SS Cable SRL
FS-FSP1220-SS	20' SS Cable SRL
FS-FSP1230-SS	30' SS Cable SRL
FS-FSP1250-SS	50' SS Cable SRL



LODESTAR

- Optimized walking speeds reduce nuisance lock-ups
- Swivel attachment point offers wide range of motion
- High-strength housing increases durability
- Built-in handle for better grip and convenience
- Fast-acting braking system quickly arrests fall
- Steel carabiner attachment
- Load-indicating swivel snap hook
- Galvanized steel cable

023-5320	30' Cable SRL
023-5321	50' Cable SRL



023-5320

CLASS 1
Anchor at or above dorsal D-ring

LODESTAR LE

- External energy absorber for edge use
- Optimized walking speeds reduce nuisance lock-ups
- Swivel attachment point offers wide range of motion
- High-strength housing increases durability
- Built-in handle for better grip and convenience
- Fast-acting braking system quickly arrests fall
- Steel carabiner attachment
- Load-indicating swivel snap hook
- Galvanized steel cable

023-5325	30' Cable SRL
023-5326	50' Cable SRL
025-5606	65' Cable SRL



023-5325

CLASS 2
Anchor above or below dorsal D-ring



CLASS 2
Anchor above or below dorsal D-ring

- Ideal for use in MEWPs and other lifts, buckets and platforms
- 360°/180° attachment point offers full range of motion
- Lightweight, durable housing for product longevity
- Convenient size tabs for easy length recognition
- Unique, reduced-size shock pack design
- Designed for foot-level connection (not a personal SRL)
- Steel carabiner attachment
- Specialized edge-resistant composite webbing

6' Single Web SRL

024-5410	Steel snap hook
024-5411	Aluminum snap hook
024-5412	Aluminum carabiner

8' Single Web SRL

025-5521	Steel snap hook
025-5522	Aluminum snap hook
025-5523	Aluminum carabiner

11' Single Web SRL

025-5524	Steel snap hook
025-5525	Aluminum snap hook
025-5526	Aluminum carabiner



Top warning label ensures proper anchor point connection



- Lightweight, durable housing for product longevity
- 360°/180° attachment point offers full range of motion
- Smoother retraction with side payout
- Specialized edge-resistant engineered composite webbing

6' Single Web SRL-P

024-5376	Steel snap hook
024-5377	Steel rebar hook
024-5378	Aluminum snap hook
024-5379	Aluminum rebar hook
024-5380	Aluminum carabiner

8' Single Web SRL-P

023-5340	Steel snap hook
023-5341	Steel rebar hook
023-5342	Aluminum snap hook
023-5343	Aluminum rebar hook
023-5344	Aluminum carabiner

11' Single Web SRL-P

024-5386	Steel snap hook
024-5387	Steel rebar hook
024-5388	Aluminum snap hook
024-5389	Aluminum rebar hook
024-5390	Aluminum carabiner

CLASS
2
Anchor above or below dorsal D-ring



Compact design shock pack with harness restraint strap



Exclusive dorsal attachment bracket with SRL separator



023-5348

6' Dual Web SRL-P

024-5381	Steel snap hooks
024-5382	Steel rebar hooks
024-5383	Aluminum snap hooks
024-5384	Aluminum rebar hooks
024-5385	Aluminum carabiners

8' Dual Web SRL-P

023-5345	Steel snap hooks
023-5346	Steel rebar hooks
023-5347	Aluminum snap hooks
023-5348	Aluminum rebar hooks
023-5349	Aluminum carabiners

11' Dual Web SRL-P

024-5391	Steel snap hooks
024-5392	Steel rebar hooks
024-5393	Aluminum snap hooks
024-5394	Aluminum rebar hooks
024-5395	Aluminum carabiners



- All the Latitude Edge features with tie-back convenience
- Wrap around a rated structure and connect tie-back hook to webbing
- Enhanced mobility, versatility and cost savings

024-5402	8' Single Web SRL-P: 20" Tie-Back
024-5403	8' Dual Web SRL-P: 20" Tie-Back
024-5404	8' Single Web SRL-P: 40" Tie-Back
024-5405	8' Dual Web SRL-P: 40" Tie-Back



024-5402

024-5403



- All the Latitude Edge features with galvanized steel cable
- Frameless design creates thinner housing

CLASS 2
Anchor above or below dorsal D-ring

8' Single Cable SRL-P

023-5350	Steel snap hook
023-5351	Steel rebar hook
023-5352	Aluminum snap hook
023-5353	Aluminum rebar hook
023-5354	Aluminum carabiner

11' Single Cable SRL-P

025-5541	Steel snap hook
025-5542	Steel rebar hook
025-5543	Aluminum snap hook
025-5544	Aluminum rebar hook
025-5545	Aluminum carabiner

8' Dual Cable SRL-P

023-5355	Steel snap hooks
023-5356	Steel rebar hooks
023-5357	Aluminum snap hooks
023-5358	Aluminum rebar hooks
023-5359	Aluminum carabiners

11' Dual Cable SRL-P

025-5546	Steel snap hooks
025-5547	Steel rebar hooks
025-5548	Aluminum snap hooks
025-5549	Aluminum rebar hooks
025-5550	Aluminum carabiners

023-5354



023-5355



LATITUDE
EDGE TIE BACK

- All the Latitude Edge features with tie-back convenience
- Wrap around a rated structure and connect tie-back hook to webbing
- Enhanced mobility, versatility and cost savings

023-5360	7' Single Cable SRL-P: 20" Tie-Back
023-5361	7' Dual Cable SRL-P: 20" Tie-Back
023-5362	7' Single Cable SRL-P: 40" Tie-Back
023-5363	7' Dual Cable SRL-P: 40" Tie-Back



023-5360

023-5361

CLASS
2
Anchor above or below dorsal D-ring

LATITUDE
EDGE

- Mesh-lined protective shock pack cover for cool-air comfort
- Durable housing for added dependability
- 360°/180° attachment point swivels for full range of motion
- Designed for sharp edge applications with foot-level connection
- Behind-the-web bracket attaches easily
- Galvanized steel cable

11' Single Cable SRL-P

SW8008-11LE	Steel snap hook
SW8008-11LE-RBH	Steel rebar hook
SW8008-11LE-ALU	Aluminum snap hook
SW8008-11LE-RBHALU	Aluminum rebar hook

11' Dual Cable SRL-P

SW8008-11LE-DL	Steel snap hooks
SW8008-11LE-RBHDL	Steel rebar hooks
SW8008-11LE-ALUDL	Aluminum snap hooks
SW8008-11LE-RBHALUDL	Aluminum rebar hooks



SW8008-11LE-ALU

SW8008-11LE-RBHDL



CLASS
1
Anchor at or above dorsal D-ring

- Reliable internal braking system eliminates need for external shock pack
- High-strength semi-sealed assembly protects internal components from debris
- 360°/180° attachment point offers full range of motion

7' Single Web SRL-P

No Attachment	Steel Carabiner	Triple Lock Carabiner	Aluminum Carabiner	
018-5000	018-5004	018-5008	018-5012	Steel snap hook
018-5002	018-5006	018-5010	018-5014	Steel rebar hook
018-5001	018-5005	018-5009	018-5013	Aluminum snap hook
018-5003	018-5007	018-5011	018-5015	Aluminum rebar hook

11' Single Web SRL-P

No Attachment	Steel Carabiner	Triple Lock Carabiner	Aluminum Carabiner	
024-5434	024-5438	024-5442	024-5446	Steel snap hook
024-5436	024-5440	024-5444	024-5448	Steel rebar hook
024-5435	024-5439	024-5443	024-5447	Aluminum snap hook
024-5437	024-5441	024-5445	024-5449	Aluminum rebar hook



018-5012



CLASS
1
Anchor at or above dorsal D-ring

7' Dual Web SRL-P



024-5453



FS-EX313, Carabiner



9013 BTW Bracket



9012 BTW Bracket

018-5016	018-5024	023-5366	Steel snap hooks
018-5018	018-5026	023-5330	Steel rebar hooks
018-5017	018-5025	021-5288	Aluminum snap hooks
018-5019	018-5027	023-5367	Aluminum rebar hooks

11' Dual Web SRL-P



FS-EX313, Carabiner



9013 BTW Bracket



9012 BTW Bracket

024-5450	024-5454	024-5458	Steel snap hooks
024-5452	024-5456	024-5460	Steel rebar hooks
024-5451	024-5455	024-5459	Aluminum snap hooks
024-5453	024-5457	024-5461	Aluminum rebar hooks



Translucent housing for easy inspection of webbing, reserve line and pawl assembly



Dyneema® webbing with superior strength and excellent abrasion resistance



- All the Latitude Pro features with tie-back convenience
- Wrap around a rated structure and connect tie-back hook to webbing
- Enhanced mobility, versatility and cost savings

CLASS 1
Anchor at or above dorsal D-ring

Tie-Back 7" Single Web SRL-P – 40" Tie-Back

No Attachment	Steel Carabiner	Triple Lock Carabiner	Aluminum Carabiner	Steel tie-back snap hook
018-5028	018-5029	018-5030	018-5031	



018-5031

Tie-Back 7" Dual Web SRL-P – 40" Tie-Back

FS-EX313	FS-EX313, Carabiner	FS-EX313, Triple Lock Carabiner	9013 BTW Bracket	9012 BTW Bracket	Steel tie-back snap hooks
018-5032	018-5033	018-5034	018-5036	023-5371	



018-5034

Tie-Back 7" Dual Web SRL-P – 20" Tie-Back

9013 BTW Bracket	9012 BTW Bracket	Steel tie-back snap hook
018-5037	023-5368	



023-5368

FALL CLEARANCE - SRLS

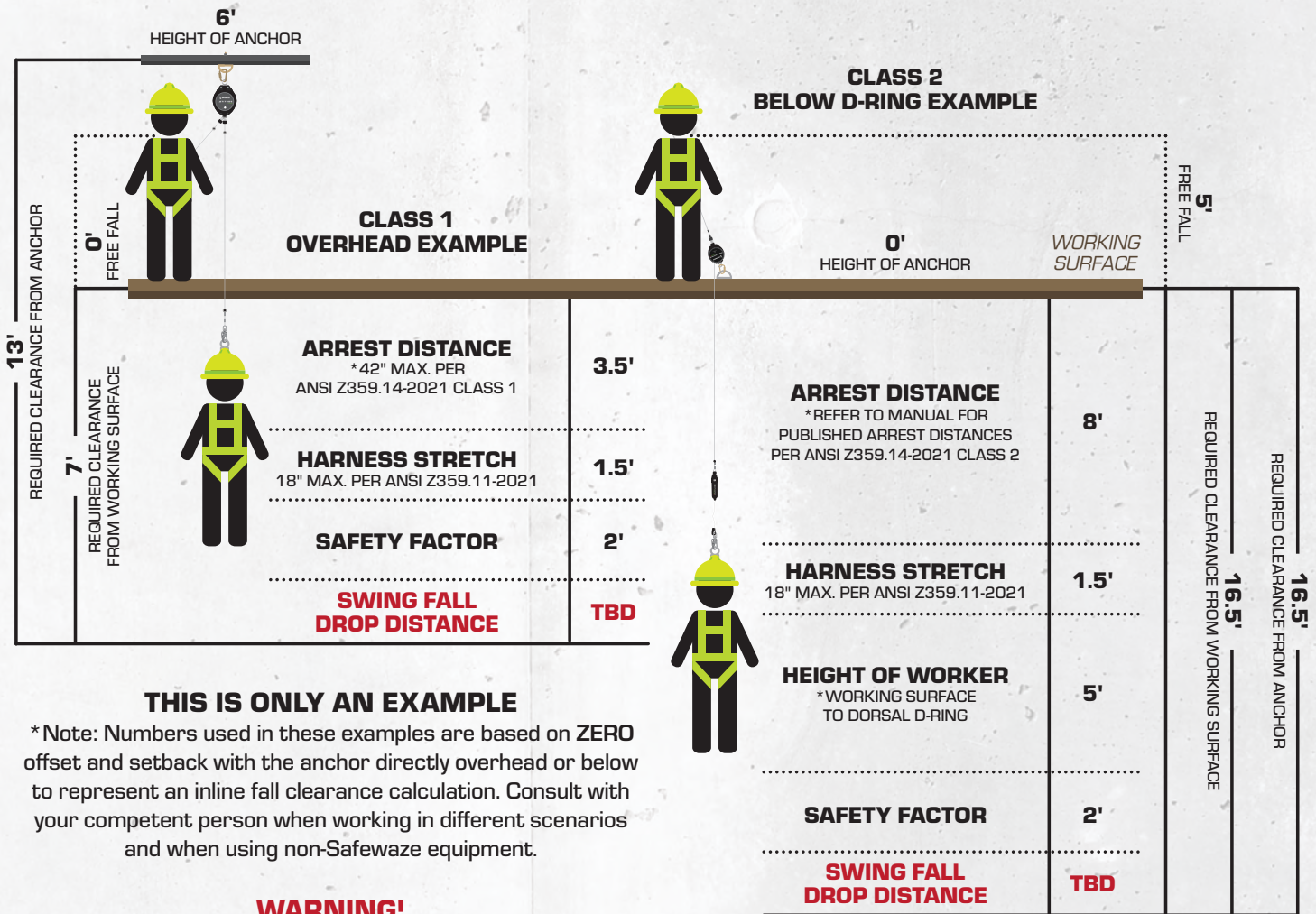

THIS IS ONLY AN EXAMPLE

* Note: Numbers used in these examples are based on ZERO offset and setback with the anchor directly overhead or below to represent an inline fall clearance calculation. Consult with your competent person when working in different scenarios and when using non-Safewaze equipment.

WARNING!

* ELIMINATE SWING FALL BY WORKING AS CLOSE TO AND INLINE TO THE ANCHORAGE AS POSSIBLE

NOTE: DO NOT EXCEED 4' SWING FALL DROP DISTANCE PER ANSI Z359.6-2016

LATITUDE

- Quick-locking system arrests falls within inches
- Optimized for low clearance where short arrest is critical
- 360°/180° attachment point offers full range of motion
- Durable housing increases strength and longevity
- High-strength, lightweight UHMPE webbing

CLASS
1
Anchor at or above dorsal D-ring



019-5044

6' Single Web SRL-P

No Attachment	Steel Carabiner	Aluminum Carabiner	
019-5040	019-5044	019-5048	Steel snap hook
019-5042	019-5046	019-5050	Steel rebar hook
019-5041	019-5045	019-5049	Aluminum snap hook
019-5043	019-5047	019-5051	Aluminum rebar hook

11' Single Web SRL-P

No Attachment	Steel Carabiner	Aluminum Carabiner	
024-5414	024-5418	024-5422	Steel snap hook
024-5416	024-5420	024-5424	Steel rebar hook
024-5415	024-5419	024-5423	Aluminum snap hook
024-5417	024-5421	024-5425	Aluminum rebar hook

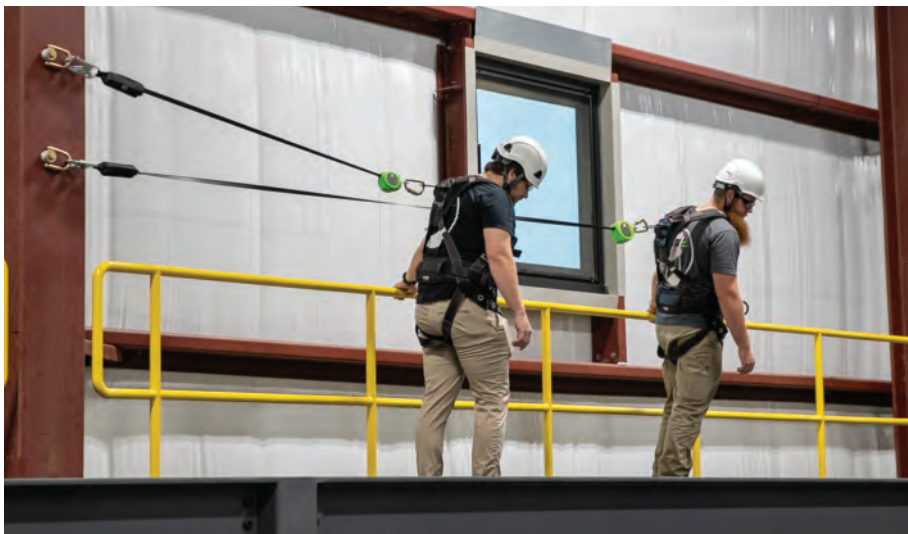



024-5433

LATITUDE

6' Dual Web SRL-P

CLASS 1
Anchor at or above dorsal D-ring



9013 BTW Bracket



9012 BTW Bracket

019-5052	019-5056	Steel snap hooks
019-5054	019-5058	Steel rebar hooks
019-5053	019-5057	Aluminum snap hooks
019-5055	019-5059	Aluminum rebar hooks

11' Dual Web SRL-P



9013 BTW Bracket



9012 BTW Bracket

024-5426	024-5430	Steel snap hooks
024-5428	024-5432	Steel rebar hooks
024-5427	024-5431	Aluminum snap hooks
024-5429	024-5433	Aluminum rebar hooks

LATITUDE TIE BACK

CLASS 1
Anchor at or above dorsal D-ring

- All the Latitude features with tie-back convenience
- Innovative replaceable leg with choker style connection
- Aluminum snap hooks



021-5278

6' Dual Web SRL-P: 9013 37" SL Tie-Back



021-5282

6' Single Web SRL-P: 9013 37" SL Tie-Back



021-5279

37" Tie-Back Leg Soft loop connection

LATITUDE HD

- Heavy-duty durability designed to tackle tough jobs
- High-strength housing and premium UHMPE webbing for increased longevity
- Reliable internal braking system eliminates need for external shock pack
- Short arrest distance perfect for use in low clearance
- 360°/180° attachment point offers full range of motion

CLASS 1
Anchor at or above dorsal D-ring

7' Single Web SRL-P

Steel Carabiner	
FS-FSP1407-W	Steel snap hook
FS-FSP1407-W-RBH	Steel rebar hook



FS-FSP1407-W-RBH



FS-FSP14075-W

7' Dual Web SRL-P



FS-EX313, Carabiner



9012 BTW Bracket

FS-FSP14075-W	023-5369	Steel snap hooks
FS-FSP14085-W-RBH	023-5370	Steel rebar hooks



9' Single Web SRL-P

Steel Carabiner

FS-FSP1409-W	Steel snap hook
FS-FSP1409-W-RBH	Steel rebar hook

9' Dual Web SRL-P

FS-EX313, Carabiner

FS-FSP1409-W-DL	Steel snap hooks
FS-FSP1409-W-DL-RBH	Steel rebar hooks



FS-FSP1409-W

FS-FSP1409-W-DL-RBH



FS-FSP1411-W

FS-FSP14095-W-RBH

11' Single Web SRL-P

Steel Carabiner

FS-FSP1411-W	Steel snap hook
FS-FSP1411-W-RBH	Steel rebar hook

11' Dual Web SRL-P

FS-EX313, Carabiner

FS-FSP14095-W	Steel snap hooks
FS-FSP14095-W-RBH	Steel rebar hooks

LATITUDE HD

CLASS 1
Anchor at or above dorsal D-ring

- Heavy-duty durability designed to tackle tough jobs
- Durable polymer housing increases strength
- Short arrest distance perfect for use in low clearance
- 360°/180° attachment point offers full range of motion
- Galvanized steel cable

10' Single Cable SRL-P

Steel Carabiner	
SW8008-10	Steel snap hook
SW8008-10-RBH	Steel rebar hook
SW8008-10-ALU	Aluminum snap hook
SW8008-10-ALU-RBH	Aluminum rebar hook



SW8008-10



SW8008-10-RBH-DL

10' Dual Cable SRL-P

9012 BTW Bracket	
SW8008-10-DL	Steel snap hooks
SW8008-10-RBH-DL	Steel rebar hooks
SW8008-10-ALU-DL	Aluminum snap hooks
SW8008-10-ALU-RBHDL	Aluminum rebar hooks

LATITUDE HD

- Heavy-duty durability designed to tackle tough jobs
- High-strength housing resists impact
- Braking system activates quickly to arrest fall
- Swivel attachment point offers wide range of motion
- Steel carabiner attachment

11' Single Cable SRL-P

Galvanized Steel Cable

FS-FSP1211-G-RBH	Load-indicating swivel rebar hook
FS-FSP1211-G	Load-indicating swivel snap hook

Stainless Steel Cable

FS-FSP1211-SS	Load-indicating swivel snap hook
---------------	----------------------------------



FS-FSP1211-G

CLASS 1
Anchor at or above dorsal D-ring

LATITUDE HD TIE BACK

- All the Latitude HD features with tie-back convenience
- Wrap around a rated structure and connect tie-back hook to webbing
- Enhanced mobility, versatility and cost savings

Web SRL-P: 20" Tie-Back

	Steel Carabiner	FS-EX313, Carabiner	
7'	FS-FSP1407-W-TBH	FS-FSP14075-W-TBH	Tie-back snap hooks
11'	FS-FSP1411-W-TBH	—	



FS-FSP1407-W-TBH



FS-FSP14075-W-TBH

LODESTAR
ARC FLASH

- Technora rope lifeline:
 - Excellent resistance to heat, steam, sea water, acids and more
 - Strong and durable yet won't damage working surfaces
 - Protective UV coating, high-tensile strength and low conductivity
- Resistant to electrical arc discharge
- Swivel attachment point offers wide range of motion
- High-strength housing increases durability
- Steel carabiner attachment
- Load-indicating swivel snap hook

CLASS
1
Anchor at or above dorsal D-ring

025-5503	30' Rope SRL
025-5504	50' Rope SRL



Technora rope is ideal for demanding applications



Built-in handle for better grip and convenience



025-5503



025-5504



CLASS 2
Anchor above or below dorsal D-ring

- All the benefits of Lodestar Lift with added protection:
 - Resistant to electrical arc discharge
 - Arc Flash compliant Kevlar® webbing
- Ideal for use in MEWPs and other lifts, buckets and platforms
- 360°/180° attachment point offers full range of motion
- Lightweight, durable housing for product longevity
- Convenient size tabs for easy length recognition
- Unique, reduced-size shock pack design
- Designed for foot-level connection (not a personal SRL)



6' Single Web SRL

025-5527	Steel snap hook
025-5528	Aluminum snap hook
025-5529	Aluminum carabiner
025-5530	Dielectric snap hook

8' Single Web SRL

025-5531	Steel snap hook
025-5532	Aluminum snap hook
025-5533	Aluminum carabiner
025-5534	Dielectric snap hook

10' Single Web SRL

025-5535	Steel snap hook
025-5536	Aluminum snap hook
025-5537	Aluminum carabiner
025-5538	Dielectric snap hook



Top warning label ensures proper anchor point connection



Nomex® and aramid flame and arc resistant shock pack cover

LATITUDE
EDGE ARC FLASH

- All the benefits of Latitude Edge with added protection:
 - Resistant to electrical arc discharge
- Lightweight, durable housing for product longevity
- 360°/180° attachment point offers full range of motion
- Nomex® and aramid flame and arc resistant shock pack cover
- Arc Flash compliant Kevlar® webbing

CLASS
2
Anchor above or below dorsal D-ring

6' Single Web SRL-P

025-5506	Steel snap hook
025-5508	Steel rebar hook
025-5507	Aluminum snap hook
025-5509	Aluminum rebar hook
025-5510	Dielectric snap hook

8' Single Web SRL-P

025-5511	Steel snap hook
025-5513	Steel rebar hook
025-5512	Aluminum snap hook
025-5514	Aluminum rebar hook
025-5515	Dielectric snap hook

10' Single Web SRL-P

025-5516	Steel snap hook
025-5518	Steel rebar hook
025-5517	Aluminum snap hook
025-5519	Aluminum rebar hook
025-5520	Dielectric snap hook

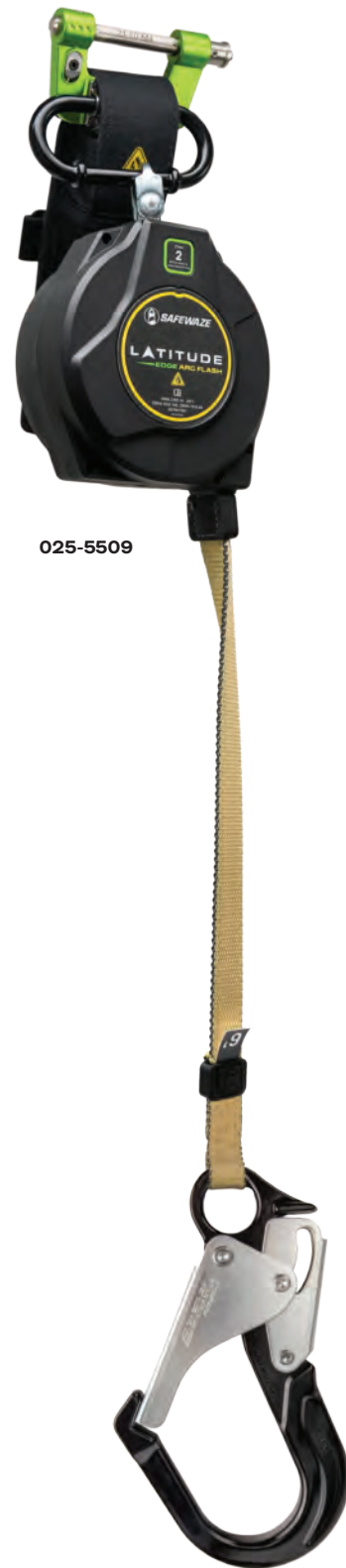

025-5509

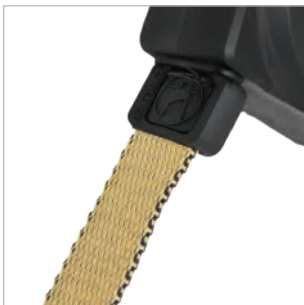

Smoother retraction with side payout



CLASS
2
Anchor above or below dorsal D-ring

6' Dual Web SRL-P

025-5551	Steel snap hooks
025-5553	Steel rebar hooks
025-5552	Aluminum snap hooks
025-5554	Aluminum rebar hooks
025-5555	Dielectric snap hooks

8' Dual Web SRL-P

025-5556	Steel snap hooks
025-5558	Steel rebar hooks
025-5557	Aluminum snap hooks
025-5559	Aluminum rebar hooks
025-5560	Dielectric snap hooks

10' Dual Web SRL-P

025-5561	Steel snap hooks
025-5563	Steel rebar hooks
025-5562	Aluminum snap hooks
025-5564	Aluminum rebar hooks
025-5565	Dielectric snap hooks



Arc Flash compliant Kevlar® webbing



LATITUDE
PRO ARC FLASH

- All the benefits of Latitude Pro with added protection:
 - Resistant to electrical arc discharge
 - Arc Flash compliant Kevlar® webbing
- Nomex® and aramid flame and arc-resistant label cover
- Reliable internal braking system eliminates need for external shock pack
- High-strength semi-sealed assembly protects internal components from debris
- 360°/180° attachment point offers full range of motion

CLASS
1
Anchor at or above dorsal D-ring

7' Single Web SRL-P



Steel Carabiner



9013 BTW Bracket

020-5200	020-5204	Steel snap hook
020-5201	020-5205	Steel rebar hook
020-5202	020-5206	Aluminum snap hook
020-5203	020-5207	Aluminum rebar hook
—	020-5208	Dielectric snap hook

7' Dual Web SRL-P



9013 BTW Bracket



9012 BTW Bracket

020-5213	020-5217	Steel snap hooks
020-5214	020-5218	Steel rebar hooks
020-5215	020-5219	Aluminum snap hooks
020-5216	020-5220	Aluminum rebar hooks
020-5221	—	Dielectric snap hooks



Translucent housing for easy inspection of webbing, reserve line and pawl assembly



020-5204



020-5219



CLASS
1
Anchor at or above dorsal D-ring

10' Single Web SRL-P



Steel Carabiner



9013 BTW Bracket

024-5482	024-5487	Steel snap hook
024-5484	024-5489	Steel rebar hook
024-5483	024-5488	Aluminum snap hook
024-5485	024-5490	Aluminum rebar hook
024-5486	024-5491	Dielectric snap hook



024-5482

10' Dual Web SRL-P



9013 BTW Bracket



9012 BTW Bracket

024-5492	024-5497	Steel snap hooks
024-5494	024-5499	Steel rebar hooks
024-5493	024-5498	Aluminum snap hooks
024-5495	024-5500	Aluminum rebar hooks
024-5496	024-5501	Dielectric snap hooks



022-5308 / ARAMID SOFT LOOP, DE SNAP HOOK

- Non-conductive connections on both ends
- Soft loop choker style attachment
- Dielectric snap hook connection



022-5309 / 13" ARAMID EXT. W/ ALU SNAP HOOK, ALU CAPTIVE EYE CARABINER

- Aramid extender blocks current between snap hook and housing
- Aluminum captive eye carabiner connection



022-5310 / 18-22" ADJ. ARAMID EXT., ALU CAPTIVE EYE CARABINERS

- Adjustable aramid extender blocks current between carabiner and housing
- Aluminum captive eye carabiners on both ends



**9013 / TRIPLE ACTION
RETRACTABLE BRACKET**

- Aluminum bracket body
- Steel swing gate for easy access
- Ultra secure connection
- Single or dual SRL use



**SW-9012 / RETRACTABLE
STEEL BRACKET**

- Quick installation
- Secure glide gate
- Single or dual SRL use

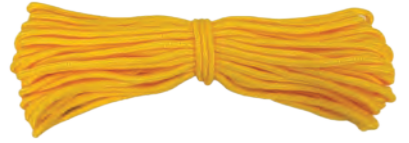

**020-9012 /
14' SRL TAGLINE ROPE**

- Safe access to devices anchored out of reach
- Distinct yellow color
- 3mm weather resistant rope

020-9012	14'
020-9013	21'
020-9014	34'
020-9015	51'

KEY - SRL Hooks

HOOK		HOOK	
Steel snap hook		Steel rebar hook	
Aluminum snap hook		Aluminum rebar hook	
Aluminum carabiner		Tie-Back snap hook	
Dielectric snap hook		Load-indicating swivel snap hook	

SELF RETRACTING LIFELINES - WEB OR CABLE?



A Web lifelines are made of high-strength synthetic woven material such as UHMPE or Kevlar®

- »» **Lightweight** – Web SRLs are typically lighter than cable SRLs making them easier to handle and more portable.
- »» **Flexible** – The webbing itself is flexible which can make movement easier for the user and is less likely to damage surfaces.
- »» **Non-Conductive** – Web materials do not conduct electricity making them safer for work near electrical hazards.
- »» **Less Durable** – Sharp and abrasive edges as well as UV light can damage or degrade most webbing materials.



B Cable lifelines are made from metal such as steel, most commonly galvanized and stainless steel.

- »» **Longevity** – Cable SRLs are corrosion resistant and protected against abrasion, sharp edges, harsh chemicals or environmental conditions
- »» **Strength** – Cable SRLs can often withstand greater forces than web SRLs making them well suited for heavy-duty applications
- »» **Heavy** – The added durability of cable SRLs means they are often heavier than web SRLs and they can cause damage to sensitive surfaces.
- »» **Inflexible** – The rigidity of cable can be more challenging for users who require frequent movement.



**INTERESTED IN THE NEWEST
RELEASES FOR VLLS?**
Scan this code to view them now!

VERTICAL LIFELINES

The hands-free, continuous movement of our vertical lifeline systems keeps you working. Whether climbing a ladder or performing maintenance on any vertical surface, our systems offer easy installation and use while maintaining a secure overhead connection.



PRO

The PRO Vertical Lifeline assortment utilizes high-strength rope with 5/8" polyester and 11mm kernmantle options.



V-LINE

The V-Line Vertical Lifeline assortment is built with super strength kernmantle rope or our abrasion resistant 5/8" copolymer rope.



FALL ARRESTERS

Critical additions or replacement parts for your vertical access VLL system. Offering top of the line fall arresters and rope grabs including both manual and trailing versions, plus complete rope grab assemblies.



COMPONENTS

Products designed specifically for your vertical access needs including termination plate anchor point, edge protectors and bulk rope.



FS700-50GA-3E / PRO 50' VERTICAL LIFELINE ASSEMBLY: SNAP HOOK, ROPE GRAB, EA LANYARD

- Ideal for roofing, swing stages, scaffolding
- UV, cut and abrasion-resistant 5/8" poly rope
- Includes manual grab and 3' energy absorbing lanyard



FS700-50GA / PRO 50' VERTICAL LIFELINE ASSEMBLY: SNAP HOOK, ROPE GRAB

- UV, cut and abrasion-resistant 5/8" poly rope
- Includes manual grab

FS700-25GA / PRO 25' Vertical Lifeline Assembly: Snap Hook, Rope Grab



FS700-50 / PRO 50' VERTICAL LIFELINE

- UV, cut and abrasion-resistant 5/8" poly rope
- Does not include manual grab

FS700-25 / PRO 25' Vertical Lifeline

FS700-75 / PRO 75' Vertical Lifeline

FS700-100 / PRO 100' Vertical Lifeline

FS700-150 / PRO 150' Vertical Lifeline

FS700-200 / PRO 200' Vertical Lifeline

FS700-250 / PRO 250' Vertical Lifeline

FS700-300 / PRO 300' Vertical Lifeline



021-7019 / PRO 30' KERNMANTLE VERTICAL LIFELINE

- 7/16" polyester kernmantle rope
- Impact-resistant captive eye termination

021-7020 / PRO 50' Kernmantle Vertical Lifeline

021-7021 / PRO 100' Kernmantle Vertical Lifeline



019-7008 / V-LINE 60' KERNMANTLE VERTICAL LIFELINE ASSEMBLY: SNAP HOOK, ROPE GRAB, EA LANYARD

- 5/8" nylon/poly kernmantle rope
- Includes trailing grab and 3' energy absorbing lanyard

019-7007 / V-Line 30' Kernmantle Vertical Lifeline Assembly: Snap Hook, Rope Grab, EA Lanyard



018-7005 / V-LINE 50' VERTICAL LIFELINE ASSEMBLY: SNAP HOOK, ROPE GRAB, EA LANYARD

- Mildew and rot-resistant 5/8" copolymer rope
- Includes manual grab and 3' energy absorbing lanyard



022-7025 / DRIFT 7/16" (11MM) ROPE FALL ARRESTER

- Easy one-handed connection
- Lightweight aluminum design
- Extra smooth travel action
- Visual indicators for upright installation
- Dual use modes with easy control
- Double locking gate, anchor descent cord
- **Exclusive:** carabiner does not need to be removed from grab to connect



025-7036 / 3' MINI ENERGY ABSORBING LANYARD

- 3' web lanyard with small shock absorber
- Use with rope grabs including Drift #022-7025, VLL systems and Rescue Stretcher #025-6076



FS00SP/FS1118-3 / TRAILING ROPE GRAB ASSEMBLY

- Removable, smooth trailing grab
- Anti-panic feature, 3' energy absorbing lanyard
- Fits 5/8" rope



FS00SP/FS1118-DC-3 / SELF-TRACKING ROPE GRAB ASSEMBLY

- Removable, self-tracking grab
- 3' energy absorbing lanyard
- Fits 5/8" rope



FS00SP/FS1117-3 / MANUAL ROPE GRAB ASSEMBLY

- Non-removable, manual grab
- 3' energy absorbing lanyard
- Fits 5/8" rope



FS1118 / TRAILING SS ROPE GRAB

- Removable, smooth action
- Anti-panic feature
- Fits 5/8" rope



FS1118-DC / SELF-TRACKING ROPE GRAB

- Removable, self-tracking
- Fits 5/8" rope



FS1117 / MANUAL ROPE GRAB

- Non-removable, quick locking
- Fits 5/8" rope

FS1120 / Trailing Rope Grab

ENERGY ABSORBER

- Fixed length with easy connection
- Forged steel hardware
- Option with choke loop for versatility
- Protective shock and label cover

FS8800SP-D	18" Energy Absorber: Snap Hook, D-ring
FS8800SP-L	20" Energy Absorber: Soft Loop, Snap Hook



FS8800SP-D



FS8800SP-L



FS875 / ROPE TERMINATION PLATE

- Versatile, easy to use anchor point
- For fall protection, work positioning, rope access and rescue
- Use with 5/8" to 3/4" rope



018-9001 / 36" Rope Protector



018-9000 / 18" Rope Protector

ROPE PROTECTOR

- Built with highly durable tarpaulin material
- Strong web loop secures protector in place
- Easily positioned with hook and loop fastener

018-9000 / 18" Rope Protector

018-9001 / 36" Rope Protector



FS700-581200 / BULK LIFELINE ROPE: 1200'

- Versatile 100% premium polyester rope

FS700-58600 / Bulk Lifeline Rope: 600'



021-7014 / 5LB. ROPE COUNTERWEIGHT

- Counterweight adds tension to VLL
- Improves performance of rope grab
- Polyester cover with sand fill



**INTERESTED IN THE NEWEST
RELEASES FOR HLLS?**
Scan this code to view them now!

HORIZONTAL LIFELINES

Get the full range of motion you need across a variety of working surfaces with our range of horizontal lifeline systems. Ideal for edge and low clearance conditions as well as short or long span roofing environments. Easy installation and hands-free use for multiple users.



SAFELINK SYSTEM

Safelink cable horizontal lifeline systems offer reliable solutions for working on edges as well as other applications where horizontal work and low clearance fall hazards exist.



CABLE SYSTEM

These 2-person cable horizontal lifeline systems are built for versatility. Offered with different in-line energy absorber types for various work conditions.



DOUBLE BRAID ROPE SYSTEM

This 4-person rope horizontal lifeline system includes an energy-absorbing shock pack, lightweight double braided rope, an innovative ratcheting tensioner and swivel connection point. The ideal solution for multiple workers covering multiple applications.



KERNMANTLE ROPE SYSTEM

These 2-person rope horizontal lifeline systems are built with a steel tensioner and abrasion resistant kernmantle rope. Combined with easy storage and transport, it's the perfect solution for shorter roofing environments or larger span jobs.

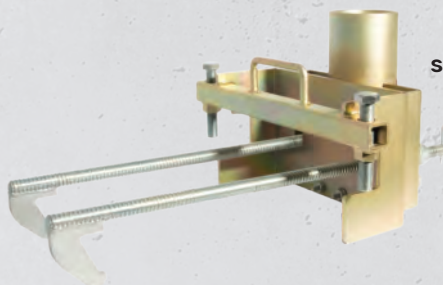

BASES

Selection of bases, stanchions, baseplates and more designed to anchor horizontal lifeline systems on a wide variety of mounting surfaces.



COMPONENTS

Essential accessories, replacement parts and individual components for all horizontal lifeline systems.



FS-EX10000 / 65' SAFELINK: COME-A-LONG

- 1-ton cable puller come-a-long
- StopLink brake assembly with tension indicator
- Corrosion-resistant cable
- Adjustable safety strap
- Fist-grip clamps, carabiners and bag



FS-EX10500 / 65' SAFELINK: TURNBUCKLE

- Turnbuckle cable tensioner
- StopLink brake assembly with tension indicator
- Corrosion-resistant cable
- Fist-grip clamps, carabiners and bag

**SAFEWAZE
SAFELINK**

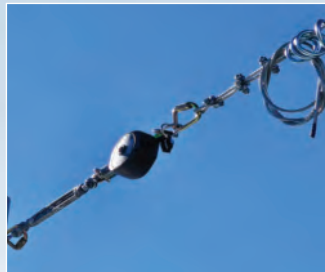



023-8091 / QUADRANT RETRACTABLE HLL

- Easy installation up to 65' length
- Light, compact design with collapsible crank
- Efficient dual-action tension release
- Built in fall indicator for easy inspection
- Freewheel mode for practical jobsite use
- Power drill adapter included for easy lifeline retraction (replacement part 023-8095)



019-8016 / 30' CABLE HLL: NO ANCHOR

- Turnbuckle cable tensioner
- Corrosion-resistant cable
- Coil energy absorber reduces impact forces
- Fist-grip clamps, carabiners, cable thimble, O-rings, bag

019-8017 / 60' Cable HLL: No Anchor

019-8018 / 80' Cable HLL: No Anchor

019-8019 / 100' Cable HLL: No Anchor



019-8020 / 30' CABLE HLL: CROSS ARM STRAPS

- Turnbuckle cable tensioner
- Corrosion-resistant cable
- Coil energy absorber reduces impact forces
- Heavy duty 6' cross arm strap anchors
- Fist-grip clamps, carabiners, cable thimble, O-rings, bag

019-8021 / 60' Cable HLL: Cross Arm Straps

019-8022 / 80' Cable HLL: Cross Arm Straps

019-8023 / 100' Cable HLL: Cross Arm Straps



019-8024 / 30' Cable HLL: CROSS ARM STRAPS, WEB ENERGY ABSORBER

- Turnbuckle cable tensioner
- Corrosion-resistant cable
- Web energy absorber reduces impact forces
- Heavy duty 6' cross arm strap anchors
- Fist-grip clamps, carabiners, cable thimble, O-rings, bag

019-8025 / 60' Cable HLL: Cross Arm Straps, Web Energy Absorber

019-8026 / 80' Cable HLL: Cross Arm Straps, Web Energy Absorber

019-8027 / 100' Cable HLL: Cross Arm Straps, Web Energy Absorber



019-8012 / 30' 4-PERSON ROPE HLL: CROSS ARM STRAPS

- Rugged double braid rope
- Ratcheting rope tensioner with energy absorber
- Swivel connection eliminates twisted rope
- Heavy duty 6' cross arm strap anchors

019-8013 / 60' 4-Person Rope HLL: Cross Arm Straps

019-8014 / 80' 4-Person Rope HLL: Cross Arm Straps

019-8015 / 100' 4-Person Rope HLL: Cross Arm Straps

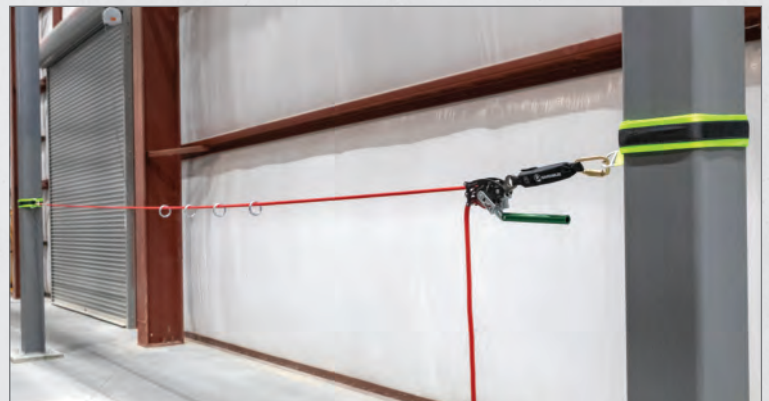
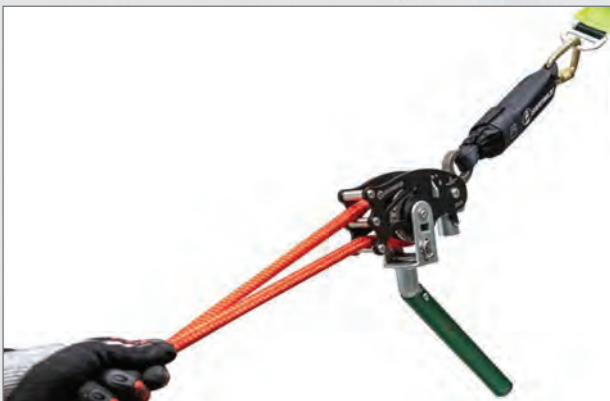



019-8000 / 30' KERNMANTLE ROPE HLL: NO ANCHOR

- Abrasion-resistant kernmantle rope
- Built-in steel rope tensioner
- Web energy absorber reduces impact forces

019-8001 / 60' Kernmantle Rope HLL: No Anchor

019-8002 / 80' Kernmantle Rope HLL: No Anchor

019-8003 / 100' Kernmantle Rope HLL: No Anchor



019-8004 / 30' KERNMANTLE ROPE HLL: CROSS ARM STRAPS

- Abrasion-resistant kernmantle rope
- Built-in steel rope tensioner
- Web energy absorber reduces impact forces
- Heavy duty 6' cross arm strap anchors

019-8005 / 60' Kernmantle Rope HLL: Cross Arm Straps

019-8006 / 80' Kernmantle Rope HLL: Cross Arm Straps

019-8007 / 100' Kernmantle Rope HLL: Cross Arm Straps



019-8008 / 30' KERNMANTLE ROPE HLL: CHAIN ANCHORS

- Abrasion-resistant kernmantle rope
- Built-in steel rope tensioner
- Web energy absorber reduces impact forces
- Easy-installation chain roof anchors

019-8009 / 60' Kernmantle Rope HLL: Chain Anchors

019-8010 / 80' Kernmantle Rope HLL: Chain Anchors

019-8011 / 100' Kernmantle Rope HLL: Chain Anchors



FS-EX2502-DBL / SAFELINK EZ-LINK DOUBLE CONNECTOR

- 3-piece aluminum bracket kit
- (4) threaded rods with wing nuts
- Mounts easily to (6) #9 rebar or larger
- Use with FS-EX5501-5 anchor posts

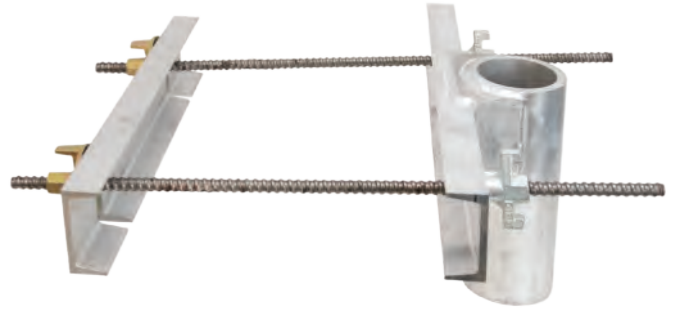

FS-EX2502 / SAFELINK FORM LINK ANCHOR

- 2-piece aluminum bracket kit
- (2) threaded rods with wing nuts
- Mounts easily to (6) #7 or larger stirruted rebar
- Mounts to finished wall (min. 8" thick)
- Clamps around finished column
- Use with FS-EX5501-5 anchor posts



FS-EX2504 / SAFELINK PVC SLEEVE

- Cast in place at 11" min. depth
- 12" length, 4" inside diameter
- Use with FS-EX5501-5 anchor posts



023-8089 / SAFELINK STEEL SLEEVE

- For use in seismic regions
- Cast in place at 11" min. depth
- 12" length, 3.7" inside diameter
- Use with FS-EX5501-5 anchor posts



FS-EX2514 / SAFELINK WHIZZLER SWIVEL CAP

- 360° swivel anchor point
- Use with FS-EX5501-5 anchor posts



019-8034 / BOLT-ON SAFELINK POST BASEPLATE

- Mounts securely to steel or concrete
- Use with FS-EX5501-5 anchor posts



019-8035 / WELD-ON SAFELINK POST BASEPLATE

- For steel bolt or weld installation
- Use with FS-EX5501-5 anchor posts



019-8046 / SAFELINK 42" I-BEAM STANCHION: 4" TO 24"

- Easily installs as single or multi-span
- Maximum 2 users per span
- Ideal for leading edge and low clearance
- Fits I-beam flanges up to 2-1/4" thick

019-8038 / SafeLink 42" I-Beam Stanchion: 4" to 18"

020-8060 / SafeLink 42" I-Beam Stanchion: 4" to 12"

019-8039 / SafeLink Pass-Through Bracket



019-8039

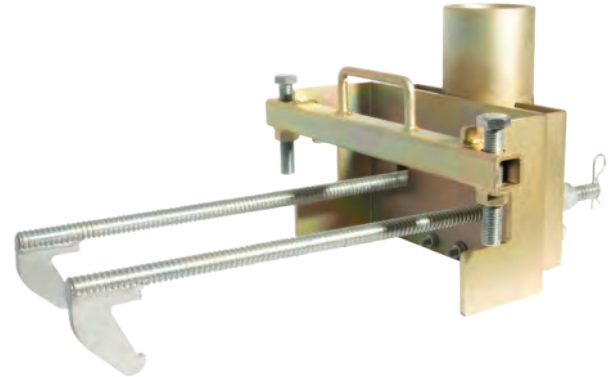

022-8076 / SAFELINK I-BEAM POST BASE: 6" TO 14"

- Easily installs as single or multi-span
- Maximum 2 users per span
- Fits I-beam flanges up to 2-1/4" thick
- Use with FS-EX5501-5 anchor posts

022-8077 / SafeLink I-Beam Post Base: 6" to 36"

SAFEWAZE SAFELINK

023-8087 / SAFELINK NELSON/REBAR ASSEMBLY

- Fits nelson stud, L-shaped and straight rebar
- Quick installation as single or multi-span
- Most versatile base for bridge work
- Maximum 2 users per span
- Use with FS-EX5501-5 anchor posts

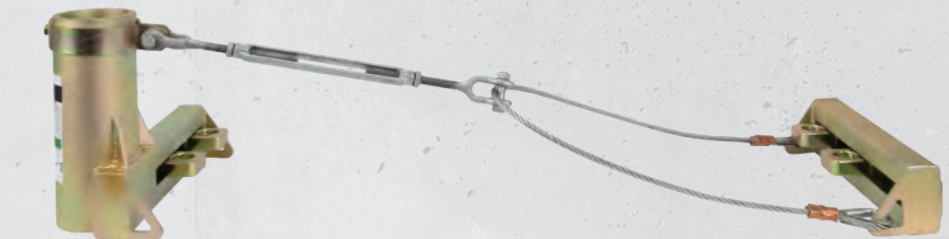



Single Span Installation

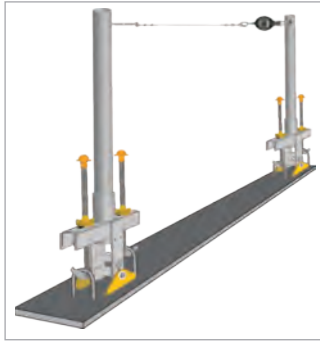

Intermediate Span Installation

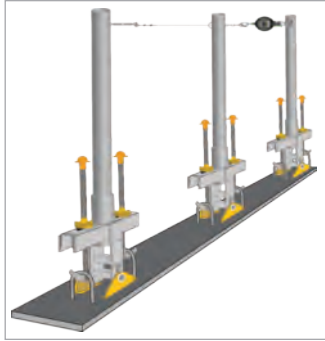

019-8051 / SAFELINK LOOP REBAR BASE

- Lightweight construction
- Perfect for overpasses, bridges and roadwork
- Adjustable base to fit angled surfaces
- Qualified person required for installation



019-8044 / STOPLINK BRAKE V2

- Exclusive brake design reduces force
- Optimized for minimum fall clearance
- Integrated tension indicator with easy view window



019-8031 / TENSION INDICATOR

- Easy view activation window
- Color coded indicator saves time
- High memory/rebound spring



019-8028 / COIL ENERGY ABSORBER: SHACKLES

- Expansion or replacement part
- Lightweight, easy set-up and use
- Versatile use with most cable HLL systems

019-8029 / Coil Energy Absorber



**019-8030 / HLL ENERGY ABSORBER:
SHACKLE**

- Efficient tear webbing reduces force
- Durable abrasion-resistant cover
- Use with rope and cable HLL systems



FS-EX2510 / SAFELINK COME-A-LONG

- 12' of high-strength aircraft cable
- Comfortable rubber grip handle



**FS-EX320 / SAFELINK
SNATCH BLOCK**

- Protective coating and locking bolt
- Swivel shackle for full rotation



**FS-EX2505 / SAFELINK
STRAP**

- Adjustable length up to 4'
- Installs as a backup safety point for the come-a-long



**FS-EX5501-5 / SAFELINK
ANCHOR POST**

- Sturdy, lightweight aluminum
- Secures overhead lifeline
- 7.5' height, 3.5" outer diameter
- Use with most SafeLink bases



**FS-EX2508 / SAFELINK
EYE BOLT**

- Secure cable connection point
- Use with FS-EX5501-5 anchor posts



**FS-EX2500-GA / SAFELINK
STEEL CABLE**

- Corrosion-resistant with captive eye on one end
- Sold by the foot for use on subdued or leading edge



**019-8036 / SAFELINK
TURNBUCKLE**

- Adjusts from 18" to 28"
- Shackle ends with locking bolts



**019-8050 / SAFELINK
FIST GRIP**

- Built for 5/16" cable



**019-8040 / SAFELINK
I-BEAM UPRIGHT**

- Replacement part for 019-8046



**019-8047 / SAFELINK
I-BEAM BASE: 4" TO 18"**

- Includes clamp, fasteners and mounting bolts
- Replacement part for 019-8046, 019-8060, 019-8038

**019-8041 / SafeLink I-Beam
Base: 4" to 24"**



**019-8042 / SAFELINK
I-BEAM CLAMP:
4"-24"**

- Replacement part for 019-8038

**019-8045 / SafeLink
I-Beam Clamp: 4"-18"**



**022-8078 / SAFELINK
I-BEAM POST BASE
CLAMP: 6"-14"**

- Replacement part for 019-8076

**022-8079 / SafeLink I-Beam
Post Base Clamp: 6"-36"**



**023-8093 / SAFELINK
NELSON/REBAR
COLLARED BASE**

- Standalone intermediate base
- Replacement part for 023-8087
- Includes clamps and wingnuts



**023-8094 / SAFELINK
NELSON/REBAR
SUPPORT BASE**

- Replacement part for 023-8087
- Not for standalone use
- Includes clamps and wingnuts



**023-8092 / SAFELINK
NELSON/REBAR
CLAMP SET**

- Fits nelson stud, L-shaped and straight rebar
- Replacement for 023-8087, 023-8093, 023-8094



**019-8043 / SAFELINK
CLAMP WING NUT**

- Replacement part for all sizes of SafeLink I-Beam Clamps



**019-8032 / HLL
INSTALLATION KIT**

- Comprehensive starter kit
- Compact, lightweight coil energy absorber
- Turnbuckle tensioner for 5/16" cable



**019-8033 / HLL
TERMINATION KIT**

- Replacement kit to secure ends
- Built for 5/16" cable



**019-8037 / SAFELINK
HEAVY DUTY
SHACKLE**

- Durable bolt fastener with secure pin
- Used for connection on all HLLs



**SW-EX177 / SAFELINK
WING NUT BRACKET**

- Replacement for FS-EX2502, FS-EX2502-DBL



**SW-EX178 / SAFELINK
WING NUT**

- Replacement for FS-EX2502, FS-EX2502-DBL



**023-8095 / POWER
DRILL ADAPTER FOR
QUADRANT**

- Replacement part for 023-8091

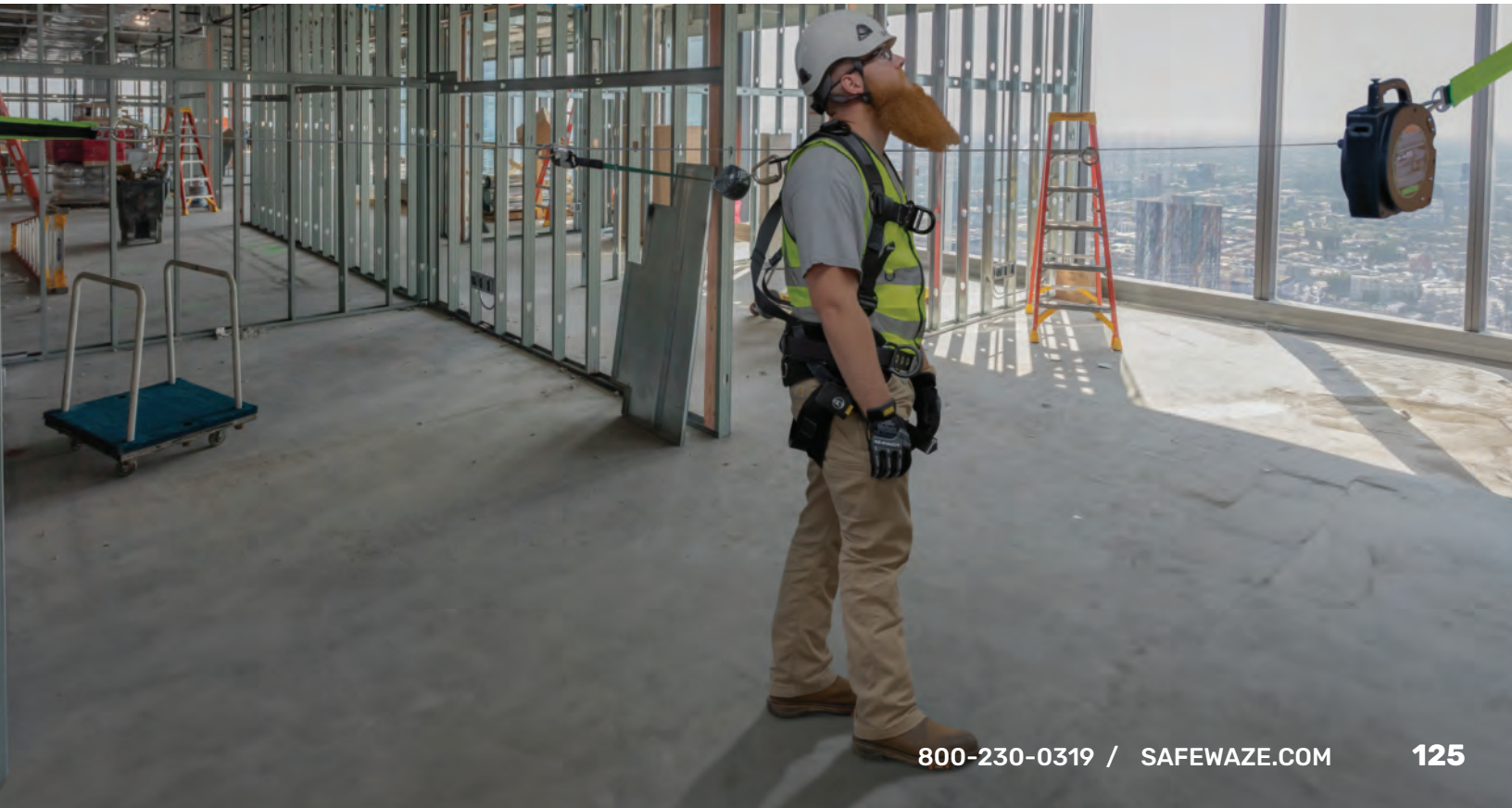



LADDER CLIMB SYSTEMS

Take the next step in ladder safety with our flexible cable systems engineered to deliver long-lasting durability. Easy to install with permanent one-time setup, including options to ensure safe rooftop transitions, save time with access for multiple users or custom build your system.



2-PERSON SYSTEM

2-Person flexible cable ladder climbing system with options in a wide range of heights.

2-Person and 4-Person systems available in original galvanized steel and also in corrosion-resistant stainless steel.





2-PERSON/ EXTENDED TOP SYSTEM

2-Person flexible cable ladder climbing system with extended top to ensure safe rooftop transitions.



4-PERSON SYSTEM

4-Person flexible cable ladder climbing system for faster access with multiple users.



LADDER ANCHORS

Permanent or temporary anchorage for SRLs. System attaches to existing ladder rungs.



HATCH SYSTEMS

Open, close and secure roof access hatches from ground level. Includes post for safe rooftop transitions.



COMPONENTS

Additional system parts or replacement parts to build your own system. The component section covers it all.



019-12001/ **20' LADDER CLIMB SYSTEM, COMPLETE KIT**

- 2-person energy absorbing top bracket with single user anchor point
- 3/8" corrosion-resistant cable
- Tension-retaining base bracket
- Intermediate guide sold separately

PART NUMBER Galvanized Steel	PART NUMBER Stainless Steel	LENGTH
019-12001	022-12111	20 ft.
019-12002	022-12112	30 ft.
019-12003	022-12113	40 ft.
019-12004	022-12114	50 ft.
019-12005	022-12115	60 ft.
019-12006	022-12116	70 ft.
019-12007	022-12117	80 ft.
019-12008	022-12118	90 ft.
019-12009	022-12119	100 ft.

019-12032 / **30' EXTENDED TOP LADDER CLIMB SYSTEM, COMPLETE KIT**

- 4' extended top for use with handrails
- 2-person energy absorbing top bracket with single user anchor point
- 3/8" corrosion-resistant cable
- Tension-retaining base bracket
- Intermediate guide sold separately

GALVANIZED STEEL	LENGTH
019-12032	30 ft.
019-12034	50 ft.
019-12036	70 ft.
019-12038	90 ft.





019-12041 / **30' LADDER CLIMB SYSTEM, 4-PERSON COMPLETE KIT**

- 4-person energy absorbing top bracket with single user anchor point
- 3/8" corrosion-resistant cable
- Tension-retaining base bracket
- Intermediate guide sold separately

PART NUMBER Galvanized Steel	PART NUMBER Stainless Steel	LENGTH
019-12041	022-12128	30 ft.
019-12043	022-12130	50 ft.
019-12045	022-12132	70 ft.
019-12047	022-12134	90 ft.

022-12146 / **4' ADJUSTABLE SRL LADDER ANCHOR SYSTEM**

- Adjustable for sternal or dorsal connection
- Versatile for use with all SRLs
- Easy attachment on fixed ladders only

PART NUMBER	DESCRIPTION
022-12146	4' Adjustable SRL Ladder Anchor System
022-12147	6' Adjustable SRL Ladder Anchor System



Adjustable captive eye

023-12154 / 10' TO 20' BELMONT SAFETY HATCH SYSTEM WITH FLAT BRACKETS

- System mounts directly to ladder for stability
- Ground level operation to open, close and secure hatch
- Safe transitions with built-in extension pole
- Manually operated drive unit with simple crank
- For use on hatches from 30" square to 36" square

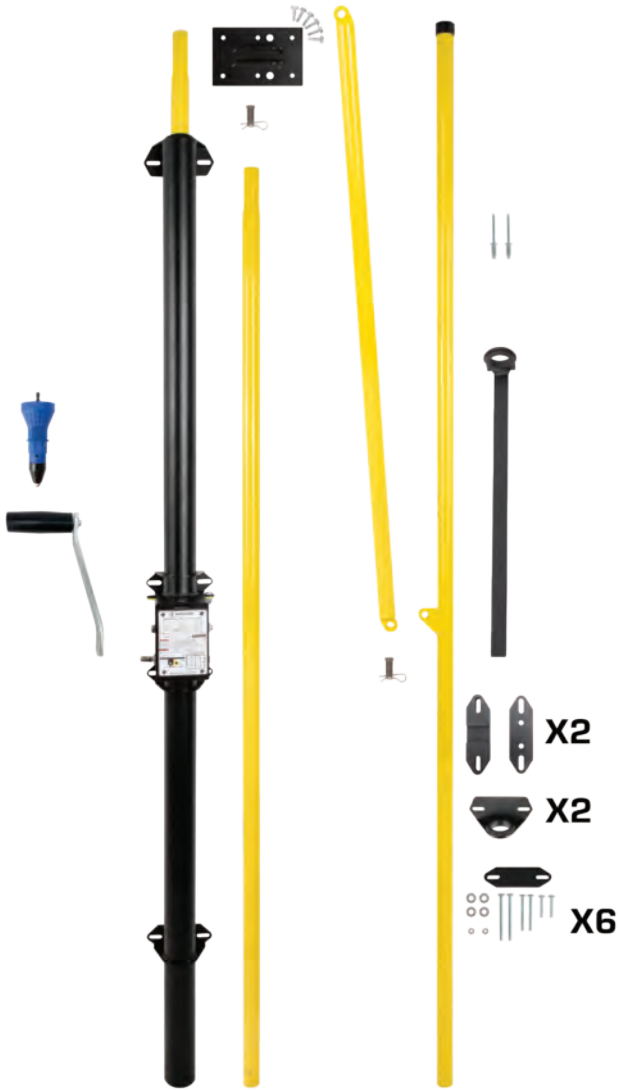

PART NUMBER	DESCRIPTION
023-12154	10' to 20' Belmont Safety Hatch System with Flat Brackets
023-12155	20' to 27' Belmont Safety Hatch System with Flat Brackets
023-12156	27' to 34' Belmont Safety Hatch System with Flat Brackets
023-12157	10' to 20' Belmont Safety Hatch System with Front Mount Brackets
023-12158	20' to 27' Belmont Safety Hatch System with Front Mount Brackets
023-12159	27' to 34' Belmont Safety Hatch System with Front Mount Brackets
023-12160	10' to 20' Belmont Safety Hatch System with Round Brackets
023-12161	20' to 27' Belmont Safety Hatch System with Round Brackets
023-12162	27' to 34' Belmont Safety Hatch System with Round Brackets
023-12163	Flat Backing Plate Set, Belmont Safety Hatch
023-12164	Front Mount Backing Plate Set, Belmont Safety Hatch
023-12165	Round Backing Plate Set, Belmont Safety Hatch



019-12022 / TOP BRACKET ASSEMBLY (2-PERSON)

- Energy absorbing, powder coated head
- Corrosion-resistant galvanized steel post
- 3,600 lb. single user anchor point

022-12102 / SS Top Bracket Assembly (2-Person)



019-12023 / 4' EXTENDED TOP BRACKET ASSEMBLY (2-PERSON)

- Energy absorbing, powder coated head
- 86.5" Corrosion-resistant galvanized steel post
- 3,600 lb. single user anchor point



019-12024 / TOP BRACKET ASSEMBLY (4-PERSON)

- Energy absorbing, powder coated head
- Corrosion-resistant galvanized steel post
- 3,600 lb. single user anchor point

022-12104 / SS Top Bracket Assembly (4-Person)



019-12025 / BOTTOM BRACKET ASSEMBLY

- Spring loaded tensioner adjusts for conditions
- Corrosion-resistant galvanized steel post

022-12105 / SS Bottom Bracket Assembly



019-12026 / INTERMEDIATE GUIDE (90°)

- 90° angle for secure fit
- Molded rubber to protect cable
- Galvanized steel base

022-12106 / SS Intermediate Guide (90°)



019-12027 / INTERMEDIATE GUIDE (STRAIGHT)

- Straight for easy access
- Molded rubber to protect cable
- Galvanized steel base

022-12107 / SS Intermediate Guide (straight)



019-12028 / U-BOLTS

- Use with 019-12029
- Zinc-plated steel

022-12108 / SS U-bolts



022-12153 / EXTENDED U-BOLT (Adjustable SRL Ladder Anchor)

- Use with 019-12029 and 022-12152



019-12029 / NUTS (2pc Set)

- Use with 019-12028
- Plated steel

022-12109 / SS Nuts (2pc Set)



019-12030 /
BACKER BRACKET

- Corrosion-resistant galvanized steel

022-12110 / SS Backer Bracket



019-12031 /
LADDER SYSTEM LABEL

- Easily track product inspection
- Corrosion-resistant stainless steel



022-12152 /
SRL LADDER ANCHOR BACKER BRACKET

- Corrosion-resistant galvanized steel
- Use with 019-12029 and 022-12153



020-12101 /
EVO 3/8" DETACHABLE CABLE SLEEVE

- Corrosion-resistant with web energy absorber
- Secure internal cam locking system
- Anti-inversion feature for proper positioning

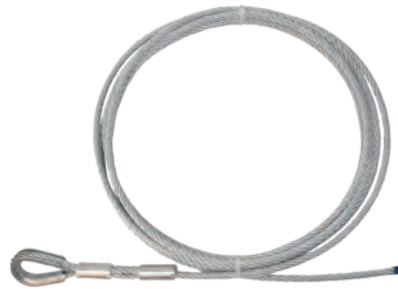

019-12012 /
20' CABLE ASSEMBLY

- 3/8" corrosion-resistant cable
- Steel thimble, pre-swaged termination

PART NUMBER Galvanized Steel	PART NUMBER Stainless Steel	LENGTH
019-12012	022-12136	20 ft.
019-12013	022-12137	30 ft.
019-12014	022-12138	40 ft.
019-12015	022-12139	50 ft.
019-12016	022-12140	60 ft.
019-12017	022-12141	70 ft.
019-12018	022-12142	80 ft.
019-12019	022-12143	90 ft.
019-12020	022-12144	100 ft.

Custom lengths available by request

INSPECTION GUIDES

All fall protection equipment should be inspected both visually and physically before each use, and at least once annually by a competent person. Visual and tactile inspections help identify early signs of wear, corrosion or damage that could compromise performance. When inspecting, handle each component closely. Remember, not all damage is visible at first glance. Consistent inspection ensures every component functions as intended, protecting working workers and maintaining compliance with safety standards.



**SCAN
TO VIEW
INSPECTION
CHECKLISTS**

HARNES INSPECTION GUIDELINE



FRAYED



CUT

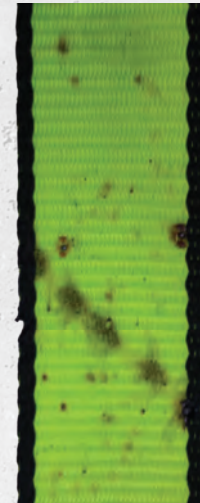

BURNED



SOILED

HARNES DEFECT CHECKLIST

WEBBING

- Excessive hardness or brittleness
- Missing straps
- Broken fibers/cracks
- Overall deterioration
- Hard or shiny spots
- Mildew (clean harness)
- Modifications by user
- Discoloration of material (depending on cause)
- Cuts, nicks or tears
- Fraying/abrasions
- Burnt charred or melted fibers

LABELING

- Check labels
- If labeling is missing or illegible, remove harness from service

HARDWARE

- Distortion (twists, bends)
- Rust or corrosion
- Broken/distorted grommets
- Modification by users (i.e. additional holes)
- Tongue buckle, mating buckle, and quick-connect should all function properly
- All adjuster springs must be in working condition

STITCHING

- Pulled stitches
- Stitching that is missing
- Fall indicators
- Hard or shiny spots
- Cut stitches
- Discoloration of stitching



**INTERESTED IN THE NEWEST RELEASES
FOR CONFINED SPACE?**
Scan this code to view them now!

CONFINED SPACE

No need to limit your work capacity when the workspace is confined. Designed to get you in easily and out safely, our dedicated confined space program supports entry and exit from utility manholes, silos, wells, sewers, storage containers, pits, pipelines and tunnels—all while working comfortably in between.



TRIPOD KITS

Our confined space tripod kits in both 7' and 10' heights serve as the support element for entry/exit into confined spaces as well as for rescue. The kits provide an anchorage for fall protection, work positioning and personnel lifts. Kits are durable yet lightweight with quick, easy setup.



ACCESSORIES

Assortment of commonly utilized components that work with our tripod kits and devices which expand the capability of your confined space system.



DEVICES

Selection of confined space devices including 3-way units, personnel winches and material winches used with our Safewaze tripods and Xtirpa systems.



COMPONENTS

Listing of critical replacement parts and components used in the confined space program.



022-11029 / 10' TECH TRIPOD BASIC

- Model Equipped With:
 - Safety chain and quick link
 - Heavy-duty storage bag



022-11033 / 10' TECH TRIPOD COMPLETE

- Model Equipped With:
 - (2) Adjustable steel steps to reach anchor points
 - Perimeter warning line to prevent fall hazards
 - Safety chain and quick link
 - Heavy-duty storage bag

ALL PREMIUM 10' TECH TRIPODS FEATURE:

- Lightweight aluminum with easy setup and quick adjustment
- Massive stance up to 18' diameter for use in trenches, mines, bridges and more
- Unique over-edge feature for use over cliffs and vertical walls
- (7) 5,000 lb. anchor points including center 360° captive eye



022-11034 / 10' TECH TRIPOD KIT: 65' PERSONNEL WINCH, 65' 3-WAY

- Model Equipped With:
 - 65' 3-Way system for fall protection
 - 65' Personnel winch safely moves workers
 - (2) Aluminum pulleys
 - (2) Steel carabiners
 - (2) Universal mounting brackets
 - Safety chain and quick link
 - Heavy-duty storage bag with wheels, handles, padding and pockets



022-11035 / 10' TECH TRIPOD KIT:
65' Material Winch, 65' 3-Way

- Model Equipped With:
 - 65' 3-Way system for fall protection
 - 65' Material winch efficiently moves gear
 - (2) Aluminum pulleys
 - (2) Steel carabiners
 - (2) Universal mounting brackets
 - Safety chain and quick link
 - Heavy-duty storage bag



022-11036 / 10' TECH TRIPOD KIT:
65' 3-Way

- Model Equipped With:
 - 65' 3-Way system for fall protection
 - Aluminum pulley
 - Steel carabiner
 - Universal mounting bracket
 - Safety chain and quick link
 - Heavy-duty storage bag



022-11037 / 10' TECH TRIPOD KIT:
65' Material Winch

- Model Equipped With:
 - 65' Material winch efficiently moves gear
 - Aluminum pulley
 - Steel carabiner
 - Universal mounting bracket
 - Safety chain and quick link
 - Heavy-duty storage bag



024-11041 / 10' TECH TRIPOD KIT:
65' Personnel Winch

- Model Equipped With:
 - 65' Personnel winch safely moves workers
 - Aluminum pulley
 - Steel carabiner
 - Universal mounting bracket
 - Safety chain and quick link
 - Heavy-duty storage bag

ALL 7' TRIPODS FEATURE:

- Lightweight aluminum with easy setup and quick adjustment
- Versatile use in confined space, rescue and evacuation
- (2) Pulleys for use with multiple devices
- (2) Additional 5,000 lb. anchor points



Swivel Pulley Bracket for easier lifeline installation



019-11004 / 7' ADJUSTABLE TRIPOD KIT, 65' PERSONNEL WINCH, 65' 3-WAY

- Model Equipped With:
 - 65' 3-Way system for fall protection
 - 65' Personnel winch safely moves workers
 - Durable bag, safety chain and quick link



019-11003 / 7' ADJUSTABLE TRIPOD KIT, 65' MATERIAL WINCH, 65' 3-WAY

- Model Equipped With:
 - 65' 3-Way system for fall protection
 - 65' Material winch efficiently moves gear
 - Durable bag, safety chain and quick link



**019-11002 /7' ADJUSTABLE TRIPOD
KIT, 65' 3-WAY**

- Model Equipped With:
 - 65' 3-Way system for fall protection
 - Durable bag, safety chain and quick link



**019-11001 /7' ADJUSTABLE TRIPOD
KIT, 65' MATERIAL WINCH**

- Model Equipped With:
 - 65' Material winch efficiently moves gear
 - Durable bag, safety chain and quick link



**021-11026 /7' ADJUSTABLE TRIPOD
KIT, 65' PERSONNEL WINCH**

- Model Equipped With:
 - 65' Personnel winch to safely move workers
 - Durable bag, safety chain and quick link



019-11000 /7' ADJUSTABLE TRIPOD

- Model Equipped With:
 - Tripod only
 - Durable bag, safety chain and quick link



019-11005 / 65' 3-WAY SRL-R SYSTEM, UNIVERSAL MOUNT

- Multi-functional as Class 1 fall protection, rescue, evacuation
- Durable aluminum housing with internal 6:1 gear ratio
- Easily stored, dual-function crank plus carrying handle
- Mounting bracket required on tripod for installation (not included)

019-11015 / 120' 3-Way System, Universal Mount



019-11009 / 65' MATERIAL WINCH

- Efficiently moves materials and tools
- Corrosion-resistant steel cable and components
- Durable, long-lasting powder-coated housing
- Mounting bracket required on tripod for installation (not included)



019-11007 / 65' PERSONNEL WINCH

- Safely moves workers with 6:1 gear ratio
- Protective plastic cable shroud
- Free-wheel mode for smooth payout
- Removable, dual-function crank plus carrying handle
- Mounting bracket required on tripod for installation (not included)

019-11008 / 115' Personnel Winch



025-11055 / 65' TECHNICAL PERSONNEL WINCH - CABLE

- Service counter monitors maintenance needs
- Safely moves workers with 1:4 manual gear ratio (1:18.9 power)
- Torque limiting coupler for use with power drill sold separately
- Free-wheel mode for quick release and smooth payout
- Mounting bracket required on tripod for installation (not included)

025-11057 / 120' Technical Personnel Winch - Cable



020-11019 / **BOSUN SEAT**

- Rugged multi-ply, sealed wood seat
- Safety strap assembly adds security
- For suspension and work positioning



020-11020 / **30" RESCUE & RETRIEVAL ASSEMBLY**

- Rigid spacer maintains strap distance
- High-strength polyester webbing
- For suspension, rescue, evacuation and confined space



022-11030 / **TRIPOD STEP (10' TRIPOD)**

- Improved reach to tripod anchor points
- Protected steel with powder coating
- Secures to 10' tech tripod leg with detent pin



022-11031 / **PERIMETER WARNING LINE (10' TRIPOD)**

- Brackets snap onto tripod legs
- Webbing threads through brackets
- Built-in adjuster tightens line for secure fit



019-9008 / **HEAVY DUTY TRIPOD BAG (7' TRIPOD)**

- Water repellent with durable zippers
- Dual shoulder straps plus handles on each end



019-9007 / **HEAVY DUTY DUFFLE BAG**

- Water repellent with durable zippers
- Rugged reinforcement and exterior storage



022-11032 / **10' TECH TRIPOD BAG**

- Heavy duty with reinforced ends and bottom
- Padded shoulder carrying strap
- Multiple handles plus convenient travel wheels
- Clearly labeled component pockets



023-11039 / **TRIPOD TIE-BACK LINE**

- 30' durable 7/16" Kernmantle rope
- Easy positioning rope adjuster
- For use with 10' Tripod in over-edge scenarios



**020-11025 / ALUMINUM
TRIPOD PULLEY**

- Easily attaches to tripod with rated carabiner
- Max use with 5/8" rope or 7/32" cable



**019-11010 / UNIVERSAL
TRIPOD BRACKET**

- Fits 7' Adjustable and 10' Tech tripods
- Connects Xtirpa confined space devices to Safewaze tripods
- Connects competitor devices using additional adapter bracket



**FS970-PK / TRIPOD
PULLEY**

- Aluminum pulley wheel
- Steel cable guide
- Mounting bolt with pin



**019-11017 / TRIPOD
REPLACEMENT CHAIN**

- 9.5' durable steel chain
- Quick link sold separately



**019-11018 / TRIPOD
QUICK LINK**

- Corrosion-resistant steel
- Secure screw lock gate



020-11022 / DETENT PIN

- Secures tripod legs in desired stance
- Fits 7' Adjustable and 10' Tech tripods



023-11040 / 7' TRIPOD PULLEY BRACKET

- Use to upgrade existing 7' Adjustable Tripod system
- Bracket swivels out for access with gap for installing lifeline
- Includes (2) brackets, (2) detent pins, (2) bolts



025-11059 / **TORQUE LIMITING COUPLER** (**TECHNICAL PERSONNEL WINCH**)

- Use with Tech Personnel Winch to increase gear ratio to 1:18.9
- Exclusive internal magnet clutch system for lasting performance
- Secures in place with detent key, no additional hardware required
- Works with standard power drill and 1/2" drill chuck



025-11060 / **REPLACEMENT HANDLE** (**TECHNICAL PERSONNEL WINCH**)

- Replacement part for Technical Personnel Winch
- Ergonomic to provide optimal leverage in manual mode
- Removable handle stores in integrated storage slot



024-11051 / **REPLACEMENT DETENT PINS FOR** **CONFINED SPACE DEVICES**

- Replacements for devices and Universal Tripod Mounting Bracket
- Includes 7.9mm and 12.7mm detent pins on key rings





XTIRPA

Xtirpa is our premium line for confined space with innovative modular solutions for fall arrest, rescue and retrieval equipment. These configurable systems have reinvented the approach to confined space with world-class manufacturing and revolutionary design to maintain a safe environment for your crew.

24" DAVIT ARM SYSTEMS

Multiple systems using the 24" Davit arm and integrated mast with floor, wall and mobile bases plus barricade and trailer hitch.

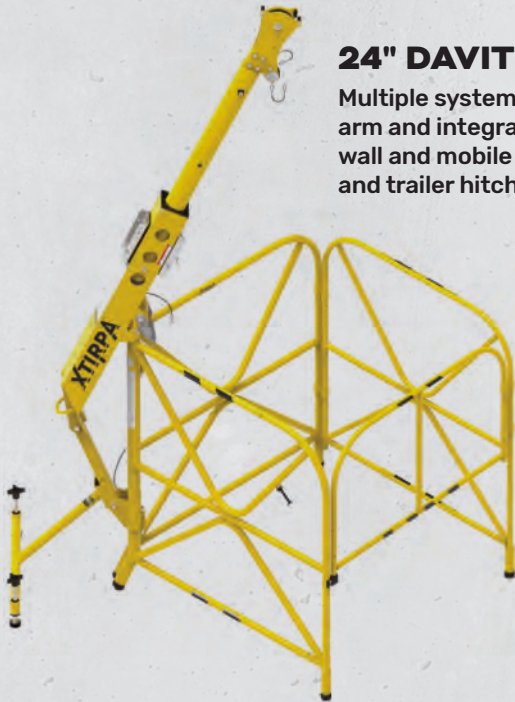

EXTENDED REACH SYSTEMS

Additional davit arms from 30"-48" and 60"-96" provide the longest reach on the market.



SPECIALTY SYSTEMS

Portable systems for both horizontal and vertical entry in tight spaces such as tanks, silos and sewers plus overhead tie-off with built-in rescue.



LIGHTWEIGHT, PORTABLE, EXPANDABLE SOLUTIONS

The interchangeable Xtirpa masts, davit arms, bases, stabilizers, weights and more work with Safewaze devices and brackets to create the perfect confined space system for your exact needs.

24" MAST-DAVIT ARM WITH FLOOR ADAPTERS SYSTEM

- Vertical Entry
- Lightweight and portable
- Easy assembly
- Davit arm expands 15"-24"



1 IN-2210



2 IN-2003

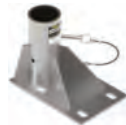

3 IN-2005



24" MAST-DAVIT ARM WITH ADJUSTABLE WALL ADAPTERS

- Vertical Entry
- Lightweight and portable
- Easy assembly
- Adjustable wall adapter for walls 6" to 15.75"
- Options available up to 45" width



1 IN-2210



2 IN-2003



3 IN-2008



BARRICADE SYSTEM

- Vertical Entry
- Lightweight and portable, self supporting
- Quick, simple assembly by one person
- Easily adjusts in seconds to fit corners
- Expandable with additional guard rails

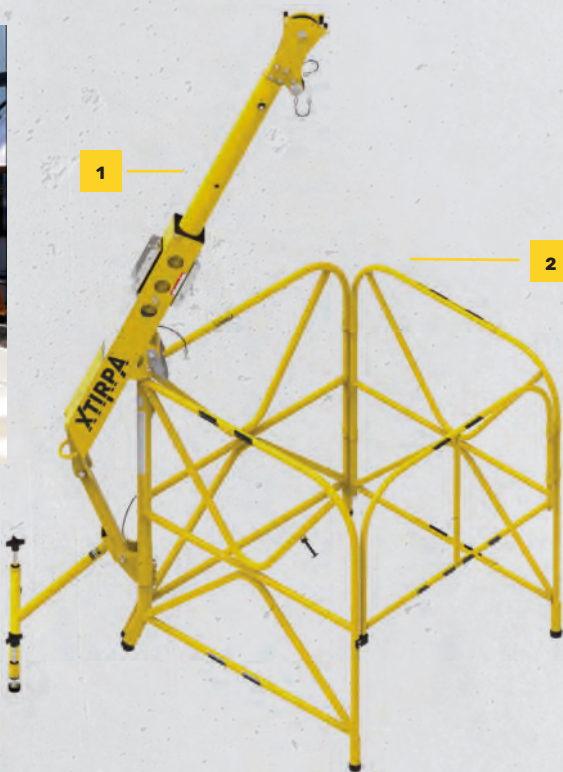

1 IN-2210



2 IN-2108



3 A21080-18



TRAILER HITCH MOUNT SYSTEM

- Vertical Entry
- Lightweight and portable
- Quick, simple assembly by one person
- Adjustable feet make leveling easy
- Use attached to vehicle or mount to supporting structure

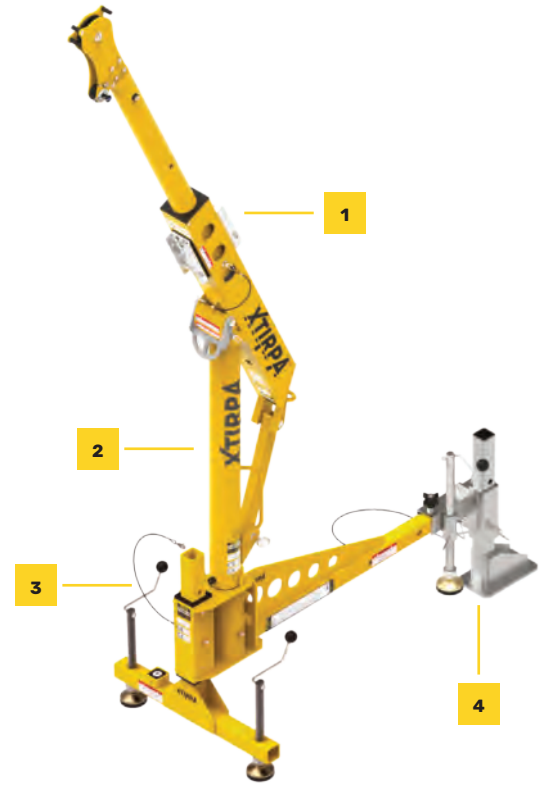
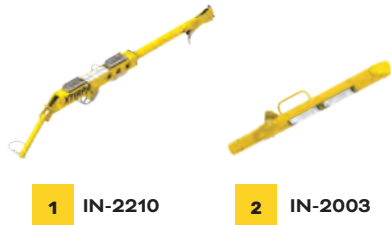

DAVIT ARM WITH MOBILE "H" BASE

- Vertical Entry
- Lightweight and portable, self supporting
- Base provides wide footprint for stable platform

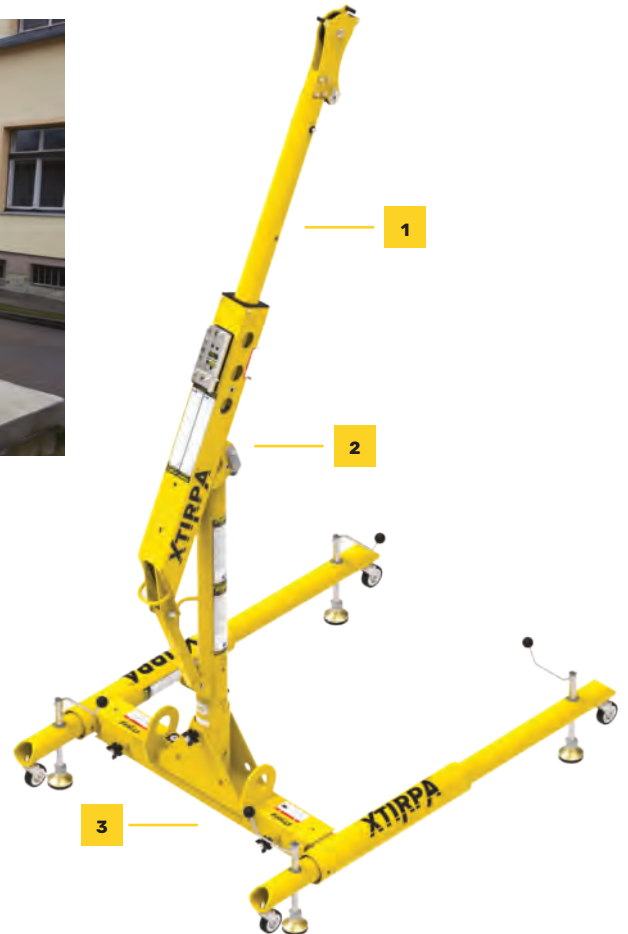

60"-96" MAST-DAVIT ARM WITH ADAPTERS

- Vertical Entry
- Portable and self supporting
- Longest davit arm on the market



1 IN-2197



2 IN-2199



3 IN-2546



30"-48" MAST-DAVIT ARM WITH ADAPTERS

- Vertical Entry
- Portable
- Easy assembly
- Three different lengths for multiple applications



1 IN-2237



2 IN-2240

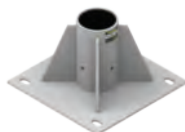

3 IN-2254



COUNTERWEIGHT SYSTEM

- Vertical Entry
- Portable and expandable
- Easy assembly
- Cost effective solution for large facilities



MODULAR SYSTEMS FOR MAXIMUM FLEXIBILITY



MULTIPLE CONFIGURATIONS

A single Xtirpa mast-davit arm connects to multiple mounts throughout a facility. Install or deploy different base options in various work zones then move the same davit arm between them as needed for utmost flexibility.

INTERCHANGEABLE BASES

Crews can set up the davit in one area then move the same arm to another floor socket or hitch mount elsewhere without needing an entirely new system. This flexibility makes the system both versatile and cost saving.



Compatible with Safewaze devices to create a complete entry and retrieval system.

POLE HOIST SYSTEM

- Horizontal and Vertical Entry
- Lightweight and portable
- Easy assembly
- 36"-45" adjustable height



1 IN-2242



2 IN-2337



3 IN-2127

XLT SYSTEM

- Portable, easy assembly
- Height 15'-25' (adjusts in 1' increments)
- Horizontal reach extends 9'
- 360° swivel with locking option

Ask about the XLT cart



1 IN-5054



2 A5039-12

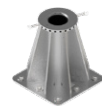

3 IN-5040



4 A5039-46



5 A5039-58



RESCUE

Every second counts in an emergency rescue situation. Preparation is key, so our experts will help you plan ahead and select the right equipment to have on hand, ready exactly when you need it.



DESCENT KITS

Comprehensive yet compact controlled descent systems that are easy to set up in an emergency evacuation for both assisted and unassisted descent.



RESCUE KITS

A range of options to help a fallen worker quickly in a variety of scenarios. From our basic rescue assist kit to rescue systems/kits with both descent and lifting capabilities.



LADDERS

Fast and easy methods of rescue while only requiring minimal advanced training. An ideal low-cost, proven rescue solution.



TRAUMA RELIEF

Suspension trauma relief provides rescue workers valuable time needed to properly rescue a worker after a fall.



COMPONENTS

Essential accessories, replacement parts and individual components for descent and rescue kits.

EVACUATION/DESCENT SYSTEMS

- Dual brake pad with 1:8.2 gear ratio
- Bidirectional for consecutive descent
- Integral belays reduce descent speed
- Built-in rope lock for added control
- Accessories included:
 - Low stretch ANSI compliant rope with captive eye
 - Carabiner for harness connection
 - 3' reinforced cross arm strap anchor
 - 18" or 36" rope protector for longevity
 - Water repellent hi-vis duffle or backpack-style gear bag



	ROPE PROTECTOR	BAG STYLE
022-6051 / 50' Evacuation/Descent System	18"	Duffle
022-6052 / 100' Evacuation/Descent System	18"	Duffle
022-6053 / 200' Evacuation/Descent System	36"	Gear
022-6054 / 300' Evacuation/Descent System	36"	Gear
022-6055 / 400' Evacuation/Descent System	36"	Gear
022-6056 / 500' Evacuation/Descent System	36"	Gear

RESCUE/DESCENT SYSTEMS & KITS

- Lifting wheel aids in disconnection for rescue
 - Dual brake pad with 1:8.2 gear ratio
 - Bidirectional for consecutive descent
 - Integral belays reduce descent speed
 - Built-in rope lock for added control
- Accessories included with all lengths:
 - Low stretch ANSI compliant rope with captive eye
 - Carabiner for harness connection
 - 3' reinforced cross arm strap anchor
 - 18" or 36" rope protector for longevity
 - Water repellent hi-vis duffle or backpack-style gear bag
 - 4'-18' Rescue Pole Kit 022-6073 included with lengths 150' and up



	ROPE PROTECTOR	BAG STYLE	RESCUE POLE KIT
022-6059 / 50' Rescue/Descent System	18"	Duffel	No
022-6060 / 100' Rescue/Descent System	18"	Duffel	No
022-6061 / 150' Rescue/Descent Kit	36"	Gear	Yes
022-6062 / 200' Rescue/Descent Kit	36"	Gear	Yes
022-6063 / 300' Rescue/Descent Kit	36"	Gear	Yes
022-6064 / 400' Rescue/Descent Kit	36"	Gear	Yes
022-6065 / 500' Rescue/Descent Kit	36"	Gear	Yes



018-6000 / RESCUE ASSIST KIT

- Ratchet assembly rated to 3,000 lbs. with carabiners
- 10' abrasion-resistant kernmantle rope assembly with carabiner
- Cable clamp rated to 1,000 lbs.
- Includes edge protector, adjustable sling and bag



020-6041 / 22' RESCUE LADDER

- Protective, water repellant carry bag with reflective trim
- High abrasion polyester webbing
- 10" wide reinforced ladder rung
- Includes (1) steel carabiner



020-6042 / 22' RESCUE LADDER WITH BELAY

- 28' abrasion-resistant kernmantle rope
- Aluminum progress capture device
- Protective, water repellant carry bag with reflective trim
- High abrasion polyester webbing
- 10" wide reinforced ladder rung
- Includes (3) steel carabiners



022-6047 / QUICK-ADJUST TRAUMA RELIEF

- Adjustable once deployed for proper step length
- Easily connects to most harnesses in seconds
- Packs attach at hips with adjuster on preferred side



024-6075 / ARC FLASH QUICK-ADJUST TRAUMA RELIEF

- Fire resistant material with Nomex® and Kevlar®
- Adjustable once deployed for proper step length
- Easily connects to most harnesses in seconds
- Packs attach at hips with adjuster on preferred side



FS902 / SUSPENSION TRAUMA STEPS

- Versatile multi-step system made from durable webbing
- Quickly attaches by choking around the dorsal D-ring
- Strap secures pack to harness webbing to prevent movement
- Corrosion resistant materials ensure pack will function when needed



022-6069 / RESCUE ASSIST SLING

- Lightweight, padded and easy to deploy
- Efficient wrap-around style with self-locking hook
- Universal sizing adjusts to fit most body types

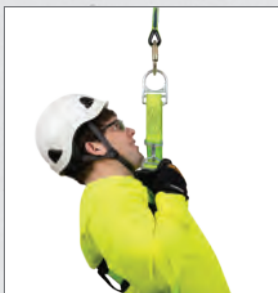



022-6070 / WEB CONNECTOR
(for rescue system)

- Ideal for use in pick-off rescue situations
- Loop attachment points for ease of use
- High strength webbing connects with most carabiners



022-6071 / ALUMINUM CARABINER
(for rescue system)

- Lightweight aluminum with anodized surface
- 3,600 lb. double action twist lock gate
- For use with the 022-6073 rescue pole



022-6072 / RESCUE POLE HEAD

- Ideal for use in pick-off rescue situations
- Holds carabiner open, snaps shut with secure connection
- For use with the 022-6073 rescue pole



022-6073 / 4-18' RESCUE POLE KIT

- Telescoping pole easily extends
- Lightweight for easier maneuverability
- Pole head bracket with carabiner clamp and anchor hook
- Includes tool attachment and tether plus protective bag



023-9087 / RESCUE GEAR BAG

- Hi-vis for easy spotting during an emergency
- Water repellent with reinforced bottom
- Labeled pockets and pole clips for organization
- Integrated backpack straps for hands-free transport



023-6074 / RESCUE PICK-OFF STRAP

- Adjustable 14"-38" for optimal positioning
- Connects between rescuer and fallen worker
- D-ring adjuster attaches to load end

025-6076 /

RESCUE STRETCHER

- Fully equipped: neck brace, rigging plate, hoist straps
- Includes backpack-style custom case for easy transport
- Ideal for complex situations and hard-to-reach locations
- Padded, adjustable head, shoulder and leg straps plus foot stirrups
- For use in horizontal, vertical or angled evacuations

**Suspension Trauma**

A fallen worker in a harness experiences restricted circulation while hanging. Serious or fatal trauma can result within minutes, so a rescue plan is critical.

Quick-Adjust Trauma Relief and Suspension Trauma Steps allow the worker to stand up in the harness, restoring circulation until help arrives.

Quick-Adjust
Trauma Relief

10' Tech Tripod

800-230-0319 / SAFEWAZE.COM

159



TOOL LANYARDS

Dropped objects are more than just a headache. In addition to lost work time, replacement costs and structural damage, the force of the object can cause severe injury or death to people below. Good news: falling objects are easily preventable with specific equipment designed for comfort and practical use in the field.



ANCHOR POINTS

Keep your tools both close at hand so you can work efficiently and securely attached so you can prevent dropped objects.



TOOL ATTACHMENTS

A tight grip is critical for dropped object prevention. Quickly secure the tools you need for the job with D-ring, choker and cinch style attachments.



TOOL TETHERS

Prevent injury, lost time and costly replacements with a secure connection between you and your tool. Available in elastic and fixed lengths.





SW424 / **5 LB. WRIST TOOL ANCHOR**

- Comfortable padding
- Velcro adjustment fits most sizes
- Allows for quick tool changes



022-10006 / **5 LB. ARC FLASH TOOL ANCHOR**

- Versatile choker style installation
- 40Cal rated aramid webbing
- Kevlar stitching
- Military grade plastic D-ring

022-10007 / 5 lb. Arc Flash Tool Anchor: 50 Pack



SW423 / **1\"/>**

- Self-adhesive, no heat required
- Versatile use (web, cinch or choker)
- For use on tools up to 2 lbs.



SW422 / **2\"/>**

- Self-adhesive, no heat required
- Versatile use (web, cinch or choker)
- For use on tools up to 5 lbs.



SW426 / **2 LB. SMALL TOOL RING: 25 Pack**

- Zinc-plated steel ring
- For use on tools up to 2 lbs.
- 1.1\"/>



SW428 / **2 LB. LARGE TOOL RING: 25 Pack**

- Zinc-plated steel ring
- For use on tools up to 2 lbs.
- 1.5\"/>



SW402 / 5 LB. D-RING TOOL ATTACHMENT:
10 Pack

- Secure with 2" Yellow Tool Tape
- Flexible, versatile use in the field



SW425 / 5 LB. ELASTICATED TOOL ATTACHMENT:
3 Pack

- Swivel D-ring for easy attachment
- Cord lock for secure grip on tools



SW408 / 15 LB. D-RING TOOL ATTACHMENT:
10 Pack

- Large D-ring for easy attachment
- Durable cord for cinch or tape attachment



SW406 / 35 LB. MEDIUM DUTY CINCH TOOL ATTACHMENT (W/ STABILIZATION TABS)

- Versatile stabilization wings
- Dual loop connection points

SW404 / 35 lb. Medium Duty Cinch Tool Attachment (No Tabs)



SW407 / 80 LB. HEAVY DUTY CINCH TOOL ATTACHMENT (W/ STABILIZATION TABS)

- Versatile stabilization wings
- Dual loop connection points



SW416



SW417

SW416 / 5 LB. 12" TOOL TETHER: 10 Pack

- Swivel clamp connectors prevent entanglement

SW417 / 5 lb. 24" Tool Tether: 10 Pack



SW414 / 2 LB. COIL TOOL TETHER

- Coated steel cable for durability
- Aluminum carabiners



SW411 / 5 LB. COIL TOOL TETHER

- Coated steel cable for durability
- Aluminum carabiners



022-10002 / **5 LB. ARC FLASH ELASTICATED TOOL TETHER:**
Carabiner, Cinch

- 40Cal rated aramid web for arc flash and high heat
- Increased range and energy absorption
- Choker end with cord lock
- Aluminum carabiner

022-10003 / 5 lb. Arc Flash Elasticated Tool Tether: 2 Carabiners



022-10004 / **15 LB. ARC FLASH ELASTICATED TOOL TETHER:** Carabiner, Cinch

- 40Cal rated aramid web for arc flash and high heat
- Increased range and energy absorption
- Choker end with cord lock
- Aluminum carabiner

022-10005 / 15 lb. Arc Flash Elasticated Tool Tether: 2 Carabiners



SW438 / **15 LB. ELASTICATED TOOL TETHER:**
Carabiner, Cinch

- Increased range and energy absorption
- Choker end with cord lock
- Aluminum carabiner

SW436 / 15 lb. Elasticated Tool Tether: 2 Carabiners



FS8016 / **15 LB. ELASTICATED TOOL LANYARD**

- Increased range and energy absorption
- Choker end with cord lock
- Small steel carabiner



SW431 / **35 LB. MEDIUM DUTY ELASTICATED TOOL TETHER**

- Internal POY energy absorber
- Increased range, reduced trip/snag hazard
- Choker style end for direct connection
- Swivel aluminum carabiner

SW432 / 35 lb. Medium Duty Elasticated Tool Tether: 2 Carabiners



SW434 / **80 LB. HEAVY DUTY ELASTICATED TOOL TETHER**

- Internal POY energy absorber
- Increased range, reduced trip/snag hazard
- Swivel aluminum carabiners

SW433 / 80 lb. Heavy Duty Elasticated Tool Tether: Loop



KITS & COMBOS

For utmost convenience and added value, these collections are grouped to meet the specific needs of an individual job or collective market. All the basic necessities are packaged together to ensure each worker is properly protected.



PRO+ KITS

A collection of premium personal fall protection components, including a PRO+ harness, grouped to meet the needs of a specific market or job site function.



PRO+ COMBOS

Two or more personal fall protection components, including a premium PRO+ harness, combined to properly outfit specific end users.



PRO KITS

A collection of personal fall protection components, including a PRO harness, grouped to meet the needs of a specific market or job site function.



PRO COMBOS

Two or more personal fall protection components, including a PRO harness, combined to properly outfit specific end users.



V-LINE KITS

A collection of economy personal fall protection components, including a V-Line harness, grouped to meet the needs of a specific market or job site function.



V-LINE COMBOS

Two or more personal fall protection components, including an economy V-Line harness, combined to properly outfit specific end users.

PRO+ KIT OPTIONS

[1] PRO+ BUCKET ROOF KIT: FS-FLEX185 HARNESS, FS700-50GA VLL, FS8800SP-H ABSORBER, FS870 ANCHOR

PART NUMBER AND HARNESS SIZE	FS155-S/M	FS155-L/XL	FS155-2X
------------------------------	-----------	------------	----------

[2] PRO+ BAG ROOF KIT: FS-FLEX185 HARN, FS700-50GA VLL, FS813 EXTENDER, FS811-20 STRAP, FS870 ANCHOR, FS8175 BAG

PART NUMBER AND HARNESS SIZE	020-3122 (S/M)	020-3123 (L/XL)	020-3124 (2X)
------------------------------	----------------	-----------------	---------------

PRO KIT OPTIONS

[1] PRO BAG KIT: FS185 HARNESS, FS580 LANYARD, FS902 TRAUMA, FS8150 BAG

PART NUMBER AND HARNESS SIZE	018-3000 (S/M)	018-3001 (L/XL)	018-3002 (2X)	020-3090 (3X)
------------------------------	----------------	-----------------	---------------	---------------

[2] PRO BAG KIT: FS185 HARNESS, 018-5025 SRL, FS902 TRAUMA, FS8150 BAG

PART NUMBER AND HARNESS SIZE	018-3003 (S/M)	018-3004 (L/XL)	018-3005 (2X)
------------------------------	----------------	-----------------	---------------

[3] PRO BAG KIT: FS285 HARNESS, FS700-50 VLL, FS1120 GRAB, FS560 LANYARD, FS870 ANCHOR, FS8175 BAG

PART NUMBER AND HARNESS SIZE	FS123-XS	FS123-S/M	FS123-L/XL	FS123-2X	FS123-3X
------------------------------	----------	-----------	------------	----------	----------

[4] PRO BUCKET ROOF KIT: FS280 HARNESS, FS700-50GA VLL, FS560 LANYARD, FS870 ANCHOR

PART NUMBER AND HARNESS SIZE	FS120-XS	FS120-S/M	FS120-L/XL	FS120-2X	FS120-3X
------------------------------	----------	-----------	------------	----------	----------

[5] PRO BUCKET ROOF KIT: FS280 HARNESS, FS700-50GA VLL, FS560-3 LANYARD, FS870 ANCHOR

PART NUMBER AND HARNESS SIZE	FS120-3-XS	FS120-3-S/M	FS120-3-L/XL	FS120-3-2X	FS120-3-3X
------------------------------	------------	-------------	--------------	------------	------------

[6] PRO BUCKET ROOF KIT: FS185 HARNESS, 018-7005 VLL, FS870 ANCHOR

PART NUMBER AND HARNESS SIZE	019-3024 (S/M)	019-3025 (L/XL)	019-3026 (2X)
------------------------------	----------------	-----------------	---------------

[7] PRO BUCKET ROOF KIT: FS280 HARNESS, 018-7005 VLL, FS870 ANCHOR

PART NUMBER AND HARNESS SIZE	FS-R00F-X-S/M	FS-R00F-X-L/XL	FS-R00F-X-2X
------------------------------	---------------	----------------	--------------

[8] PRO BAG ROOF KIT: FS185 HARNESS, FS700-50 VLL, FS1120 GRAB, FS88560-E LANYARD, FS870 ANCHOR, FS8175 BAG

PART NUMBER AND HARNESS SIZE	020-3114 (XS)	020-3115 (S/M)	020-3116 (L/XL)	020-3117 (2X)	020-3118 (3X)
------------------------------	---------------	----------------	-----------------	---------------	---------------

[9] PRO BAG ROOF KIT: FS185 HARNESS, FS700-50 VLL, FS1118-DC GRAB, FS88560-E LANYARD, FS870 ANCHOR, FS8185 BAG

PART NUMBER AND HARNESS SIZE	019-3049 (XS)	019-3050 (S/M)	019-3051 (L/XL)	019-3052 (2X)
------------------------------	---------------	----------------	-----------------	---------------

[10] PRO BAG ROOF KIT: FS185 HARNESS, FS700-50 VLL, FS1118-DC GRAB, FS560-3 LANYARD, FS870 ANCHOR, FS8150 BAG

PART NUMBER AND HARNESS SIZE	FS137-XS	FS137-S/M	FS137-L/XL	FS137-2X	FS137-3X
------------------------------	----------	-----------	------------	----------	----------

[11] PRO BAG ROOF KIT: FS185 HARNESS, FS700-50 VLL, FS1120 GRAB, FS88580 LANYARD, FS870 ANCHOR, FS8185 BAG

PART NUMBER AND HARNESS SIZE	019-3014 (S/M)	019-3015 (L/XL)	019-3016 (2X)
------------------------------	----------------	-----------------	---------------

PRO KIT OPTIONS (Continued)

[12] PRO BAG ROOF KIT: FS185 HARNESS, FS700-50GA VLL, FS560 LANYARD, FS870 ANCHOR, FS8175 BAG

PART NUMBER AND HARNESS SIZE	FS124-XS	FS124-S/M	FS124-L/XL	FS124-2X	FS124-3X
------------------------------	----------	-----------	------------	----------	----------

[13] PRO BAG KIT: FS185 HARNESS, FS700-50GA VLL, FS560-3 LANYARD, FS8175 BAG

PART NUMBER AND HARNESS SIZE	019-3011 (S/M)	019-3012 (L/XL)	019-3013 (2X)
------------------------------	----------------	-----------------	---------------

[14] PRO BAG KIT: FS185 HARNESS, FS590 LANYARD, FS811-6 ANCHOR, FS8150 BAG

PART NUMBER AND HARNESS SIZE	FS140-S/M	FS140-L/XL
------------------------------	-----------	------------

[15] PRO BAG KIT: FS185 HARNESS, 018-5009 SRL, FS811-3 ANCHOR, FS8125 BAG

PART NUMBER AND HARNESS SIZE	EX-1000-S/M	EX-1000-L/XL	EX-1000-2X
------------------------------	-------------	--------------	------------

V-LINE KIT OPTIONS / Includes Universal Harness Size

EX-3000 / V-Line Bucket Roof Kit: FS99185-E Harness, FS700-50 VLL, FS1120 Grab, FS88560-E3 Lanyard, FS870 Anchor, FS902 Trauma

019-3038 / V-Line Bucket Roof Kit: FS99281-E Harnesses, FS700-50GA-3E VLL, FS870 Anchor

FS-ROOF-E/1120: V-Line Bucket Roof Kit: FS99280-E Harness, FS700-50 VLL, FS1120 Grab, FS88860-3 Lanyard, FS870 Anchor

FS-ROOF-P / V-Line Bucket Roof Kit: FS99185-E Harness, FS700-50 VLL, FS1120 Grab, FS88560-E3 Lanyard, FS870 Anchor

020-3130 / V-Line Bucket Roof Kit: FS99185-E Harness, FS700-50 VLL, FS1118-DC Grab, FS88560-E3 Lanyard, FS870 Anchor

020-3119 / V-Line Bucket Roof Kit: FS99185-E Harness, FS700-50 VLL, FS1120 Grab, FS88560-E3 Lanyard

FS120-E/1118DC / V-Line Bucket Roof Kit: FS99280-E Harness, FS700-50 VLL, FS1118-DC Grab, FS88560-E Lanyard, FS870 Anchor

FS148 / V-Line Bucket Roof Kit: FS99280-E Harness, FS700-50GA VLL, FS88560-E Lanyard, FS870 Anchor

FS120-50 / V-Line Bucket Roof Kit: FS99185-E Harness, 018-7005 VLL, FS870 Anchor

FS-EX6000-Bucket / V-Line Bucket Roof Kit: FS99280-E Harness, FS700-50 VLL, FS1120 Grab, FS88560-E Lanyard, FS870 Anchor

FS-ROOF-E / V-Line Bucket Roof Kit: FS99280-E Harness, 018-7005 VLL, FS870 Anchor

020-3120 / V-Line Bag Roof Kit: FS99280-E Harness, FS700-100 VLL, FS1118-DC Grab, FS88560-E Lanyard, FS870 Anchor, FS8185 Bag

SW130-E / V-Line Bag Kit: FS99280-E Harness, FS-FSP1411-W SRL-P, FS811-6 Anchor, FS8150 Bag

021-3144 / V-Line Bag Kit: FS99280-E Harness, FS-FSP1411-W SRL-P, FS811-3 Anchor, FS8150 Bag

020-3075 / V-Line Bag Roof Kit: FS99185-E Harness, FS700-50 VLL, FS1120 Grab, FS88560-E Lanyard, FS870 Anchor, FS8150 Bag

019-3037 / V-Line Bag Roof Kit: FS99185-E Harness, 018-7005 VLL, FS870 Anchor, FS8185 Bag

020-3131 / V-Line Bag Roof Kit: FS99185-E Harness, FS700-50 VLL, FS1118-DC Grab, FS88560-E3 Lanyard, FS870 Anchor, FS8185 Bag

FS120-E/1118DC-BP / V-Line Bag Roof Kit: FS99280-E Harness, FS700-50 VLL, FS1118-DC Grab, FS88560-E Lan, FS870 Anchor, FS8185 Bag

FS-EX6000-DL / V-Line Bag Roof Kit: FS99280-E Harness, FS700-50 VLL, FS1120 Grab, FS88561-E Lanyard, FS870 Anchor, FS8150 Bag

FS-ROOF-E-BP / V-Line Bag Roof Kit: FS99280-E Harness, 018-7005 VLL, FS870 Anchor, FS8185 Bag

FS121-E / V-Line Bag Roof Kit: FS99280-E Harness, FS700-50GA VLL, FS88560-E Lanyard, FS870 Anchor, FS8175 Bag

FS-EX6000 / V-Line Bag Roof Kit: FS99280-E Harness, FS700-50 VLL, FS1120 Grab, FS88560-E Lanyard, FS870 Anchor, FS8150 Bag

FS-ROOF-E-BAG / V-Line Bag Roof Kit: FS99280-E Harness, 018-7005 VLL, FS870 Anchor, FS8175 Bag

020-3113 / V-Line Bag Roof Kit: FS99280-E Harness, 018-7005 VLL, FS870 Anchor, FS8150 Bag

021-3216 / V-Line Bag Roof Kit: FS99185-E Harness, 018-7005 VLL, FS870 Anchor, FS8175 Bag

PRO+ COMBO OPTION

[1] **PRO+ BAG COMBO:** FS-FLEX185 HARNESS, FS590 LANYARD, FS8150 BAG

PART NUMBER AND HARNESS SIZE	FS152-S/M	FS152-L/XL	FS152-2X
------------------------------	-----------	------------	----------

PRO COMBO OPTIONS

[1] **PRO BAG COMBO:** FS185 HARNESS, FS-FSP14075-W SRL, FS8150 BAG

PART NUMBER AND HARNESS SIZE	FS144-S/M	FS144-L/XL	FS144-2X
------------------------------	-----------	------------	----------

[2] **PRO BAG COMBO:** FS185 HARNESS, 019-5052 SRL-P, FS8150 BAG

PART NUMBER AND HARNESS SIZE	019-3039 (XS)	019-3040 (S/M)	019-3041 (L/XL)	019-3042 (2X)	019-3043 (3X)
------------------------------	---------------	----------------	-----------------	---------------	---------------

[3] **PRO BAG COMBO:** FS185 HARNESS, 018-5004 SRL, FS8150 BAG

PART NUMBER AND HARNESS SIZE	019-3005 (XS)	019-3006 (S/M)	019-3007 (L/XL)	019-3008 (2X)	019-3009 (3X)
------------------------------	---------------	----------------	-----------------	---------------	---------------

[4] **PRO BAG COMBO:** FS185 HARNESS, 018-5009 SRL, FS8150 BAG

PART NUMBER AND HARNESS SIZE	FS143-XS	FS143-S/M	FS143-L/XL	FS143-2X	FS143-3X
------------------------------	----------	-----------	------------	----------	----------

[5] **PRO BAG COMBO:** FS185 HARNESS, FS-FSP1407-W SRL, FS8150 BAG

PART NUMBER AND HARNESS SIZE	FS146-XS	FS146-S/M	FS146-L/XL	FS146-2X	FS146-3X
------------------------------	----------	-----------	------------	----------	----------

[6] **PRO BAG COMBO:** FS185 HARNESS, FS566 LANYARD, FS8150 BAG

PART NUMBER AND HARNESS SIZE	FS139-DL-XS	FS139-DL-S/M	FS139-DL-L/XL	FS139-DL-2X	FS139-DL-3X
------------------------------	-------------	--------------	---------------	-------------	-------------

[7] **PRO BAG COMBO:** FS185 HARNESS, FS565 LANYARD, FS8150 BAG

PART NUMBER AND HARNESS SIZE	FS139-XS	FS139-S/M	FS139-L/XL	FS139-2X	FS139-3X
------------------------------	----------	-----------	------------	----------	----------

[8] **PRO BAG COMBO:** FS185 HARNESS, FS560 LANYARD, FS8150 BAG

PART NUMBER AND HARNESS SIZE	FS141-XS	FS141-S/M	FS141-L/XL	FS141-2X	FS141-3X
------------------------------	----------	-----------	------------	----------	----------

[9] **PRO BAG COMBO:** FS185 HARNESS, FS561 LANYARD, FS8150 BAG

PART NUMBER AND HARNESS SIZE	FS141-D-S/M	FS141-D-L/XL	FS141-D-2X
------------------------------	-------------	--------------	------------

[10] **PRO BAG COMBO:** FS185 HARNESS, FS456 LANYARD, FS8150 BAG

PART NUMBER AND HARNESS SIZE	FS147-S/M	FS147-L/XL	FS147-2X
------------------------------	-----------	------------	----------

[11] **PRO BAG COMBO:** FS185 HARNESS, FS560-AJ LANYARD, FS8150 BAG

PART NUMBER AND HARNESS SIZE	019-3027 (S/M)	019-3028 (L/XL)	019-3029 (2X)
------------------------------	----------------	-----------------	---------------

[12] **PRO BAG COMBO:** FS185 HARNESS, FS581 LANYARD, FS8150 BAG

PART NUMBER AND HARNESS SIZE	FS133-DL-S/M	FS133-DL-L/XL	FS133-DL-2X
------------------------------	--------------	---------------	-------------

PRO COMBO OPTIONS (Continued)**[13] PRO BAG COMBO:** FS185 HARNESS, FS580 LANYARD, FS8150 BAG

PART NUMBER AND HARNESS SIZE	FS133-XS	FS133-S/M	FS133-L/XL	FS133-2X	FS133-3X
------------------------------	----------	-----------	------------	----------	----------

[14] PRO BAG COMBO: FS185 HARNESS, FS560-3 LANYARD, FS8150 BAG

PART NUMBER AND HARNESS SIZE	019-3054 (XS)	019-3055 (S/M)	019-3056 (L/XL)	019-3057 (2X)	019-3058 (3X)
------------------------------	---------------	----------------	-----------------	---------------	---------------

[15] PRO BAG COMBO: FS285 HARNESS, FS560 LANYARD, FS8150 BAG

PART NUMBER AND HARNESS SIZE	FS128-S/M	FS128-L/XL	FS128-2X
------------------------------	-----------	------------	----------

[16] PRO BAG COMBO: FS280 HARNESS, FS560 LANYARD, FS8150 BAG

PART NUMBER AND HARNESS SIZE	FS126-XS	FS126-S/M	FS126-L/XL	FS126-2X	FS126-3X
------------------------------	----------	-----------	------------	----------	----------

[17] PRO COMBO: FS280 HARNESS, FS560-4 LANYARD

PART NUMBER AND HARNESS SIZE	FS129-4-S/M	FS129-4-L/XL	FS129-4-2X
------------------------------	-------------	--------------	------------

V-LINE COMBO OPTIONS / Includes Universal Harness Size**020-3059 / V-Line Bucket Combo:** FS99280-E Harness, FS88560-E Lanyard**020-3072 / V-Line Bag Combo:** FS99185-E Harness, 019-5045 SRL-P, FS8150 Bag**FS126-E-DL / V-Line Bag Combo:** FS99280-E Harness, FS88561-E Lanyard, FS8150 Bag**FS127-E / V-Line Bag Combo:** FS99285-E Harness, FS88560-E Lanyard, FS8150 Bag**FS141-E / V-Line Bag Combo:** FS99185-E Harness, FS88560-E Lanyard, FS8150 Bag**FS126-E-3D / V-Line Bag Combo:** FS99281-E Harness, FS88560-E Lanyard, FS8150 Bag**019-3036 / V-Line Combo:** FS99185-E Harness, FS88560-E Lanyard**FS126-E / V-Line Bag Combo:** FS99280-E Harness, FS88560-E Lanyard, FS8150 Bag**020-3129 / V-Line Bag Combo:** FS99280-E Harness, FS88580 Lanyard, FS8150 Bag**019-3034 / V-Line Bag Combo:** FS99185-E Harness, FS88560-E Lanyard, FS8125 Bag**019-3035 / V-Line Bag Combo:** FS99280-E Harness, FS88561-E Lanyard, FS8125 Bag**FS129-E / V-Line Combo:** FS99280-E Harness, FS88560-E Lanyard



REPAIRS MADE EASY

START WITH THE DISTRIBUTOR

Only the company who purchased the SRL from Safewaze can initiate the repair process.



REPAIR REQUEST FORM

The distributor will complete the repair form and include a purchase order number for authorization.



SHIPPING

The distributor will send the SRL and completed form to the Safewaze Repair Department.



INSPECTION

Our Repair Department will inspect the SRL. An inspection fee will apply if user chooses not to make repairs.



QUOTE

A repair quote will be sent to the contact person listed on the form.



REPAIR

Once Safewaze receives approval, our technicians will begin the authorized repair.



RETURN

The SRL will be shipped back to the distributor unless noted on the repair form. *Shipping charges may apply.*



Serviceable/Repairable

SRL

Why Repair Your SRL?

- **SAVE MONEY:**
Repair is significantly less expensive than buying a new unit, often up to 50% savings.
- **MINIMIZE DOWNTIME:**
Safewaze completes service quickly to keep your equipment – and your workers – on the job.
- **STAY SAFE:**
Repairs completed by certified service centers maintain the equipment's integrity, ensuring it's as dependable as when it was new.
- **STAY COMPLIANT:**
Completed work is rigorously tested to ensure your SRL adheres to all applicable OSHA and ANSI standards.

FINISH WITH CONFIDENCE

Your SRL is now ready to return to service! Certified service and repair from Safewaze provides complete confidence to put your workers back on the job with equipment they can trust.



ACCESSORIES

In fall protection, accessories are not just for decoration. They are an integral part of the safety system, each with its own job to do, making the product more efficient or versatile. Bonus, ours look good while doing it.



CARABINERS

Aluminum and steel carabiners used in part of a personal fall protection system.



BAGS

Personal fall protection equipment storage and travel bags.



FS1026 / LARGE STEEL CARABINER WITH CAPTIVE PIN

- Twist lock gate
- Large gate opening 2.13"



FS1018 / ALUMINUM BOA CARABINER WITH CAPTIVE PIN

- Twist lock gate
- Large gate opening 2.05"



FS1017 / STEEL BOA CARABINER WITH CAPTIVE PIN

- Twist lock gate
- Large gate opening 2.01"



FS1025 / STEEL CARABINER WITH CAPTIVE PIN

- Twist lock gate
- Large gate opening 1.18"



FS1016-GR / SMALL ALUMINUM CARABINER

- Twist lock gate
- Gate opening .88"



FS1015 / SMALL STEEL CARABINER

- Twist lock gate
- Gate opening .75"



019-9002 / OVAL STEEL TRIPLE LOCK CARABINER

- Triple lock gate
- Gate opening .55"



021-9039 / SMALL STEEL CARABINER WITH CAPTIVE PIN

- Twist lock gate
- Gate opening .75"



021-9068 / SMALL ALUMINUM BOA CARABINER

- Twist lock gate
- Gate opening .94"



FS8185 / HEAVY DUTY GEAR BAG - XL

- Backpack style carry straps
- Large opening with drawstring closure
- Internal storage and accessory D-rings



025-9106 / SHUTTLE BAG

- Durable, reflective, water repellent bag
- Versatile attachment with loop and small magnetic carabiner
- Convenient tool bag or use with Shuttle Anchor



FS8175 / 25" DUFFLE BAG



FS8150 / 20" DUFFLE BAG



FS8125 / 13" DUFFLE BAG



EDUCATION & TRAINING

Safewaze makes it easy to keep your team engaged with education and training from the ground up. Our dedicated experts offer multiple ways to stay safe, delivering exactly what you need, whenever and wherever you need it – on your job site or at our new state-of-the-art testing and training facility.

JOB SITE DEMOS: Fall Protection Product Demonstrations

- Learning on Location
- Expert Sales Instruction
- Popular Offerings
 - » Equipment demos and use
 - » PPE inspection
 - » Dynamic drop tests
 - » ABCs of fall protection
- Readily Available
- No Cost
- Questions? info@safewaze.com





SAFEWAZE ACADEMY: Next-Level Fall Protection Experience

Safewaze Academy delivers practical, expert-led learning that bridges the gap between classroom activity and real-world safety. Every course is immersive and hands-on, leaving attendees with confidence to work at height.

- **Immersive Learning:** Full engagement through combined lecture and hands-on modules — on the ground and at height
- **Top-Notch Environment:** Private classroom plus an impressive state-of-the-art testing and training lab
- **Expert Instruction:** Led by Becky Danielson, a dedicated professional with over 20 years of work-at-height experience
- **Diverse Course Offerings:**
 - » Competent Person
 - » EM385 Competent Person
 - » Industrial Rescuer
 - » More courses added regularly based on industry demand
- **Accredited Completion:** Certificate and wallet card issued
- **Refresher and Recertification Courses**
- **Private Options:** Custom courses available by request
- **Questions?** training@safewaze.com

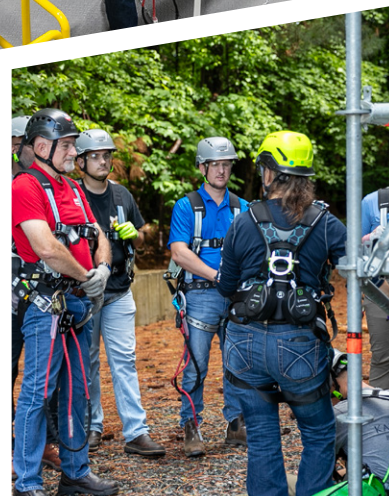

**SAFEWAZE
ACADEMY**
Scan for course
calendar and
registration

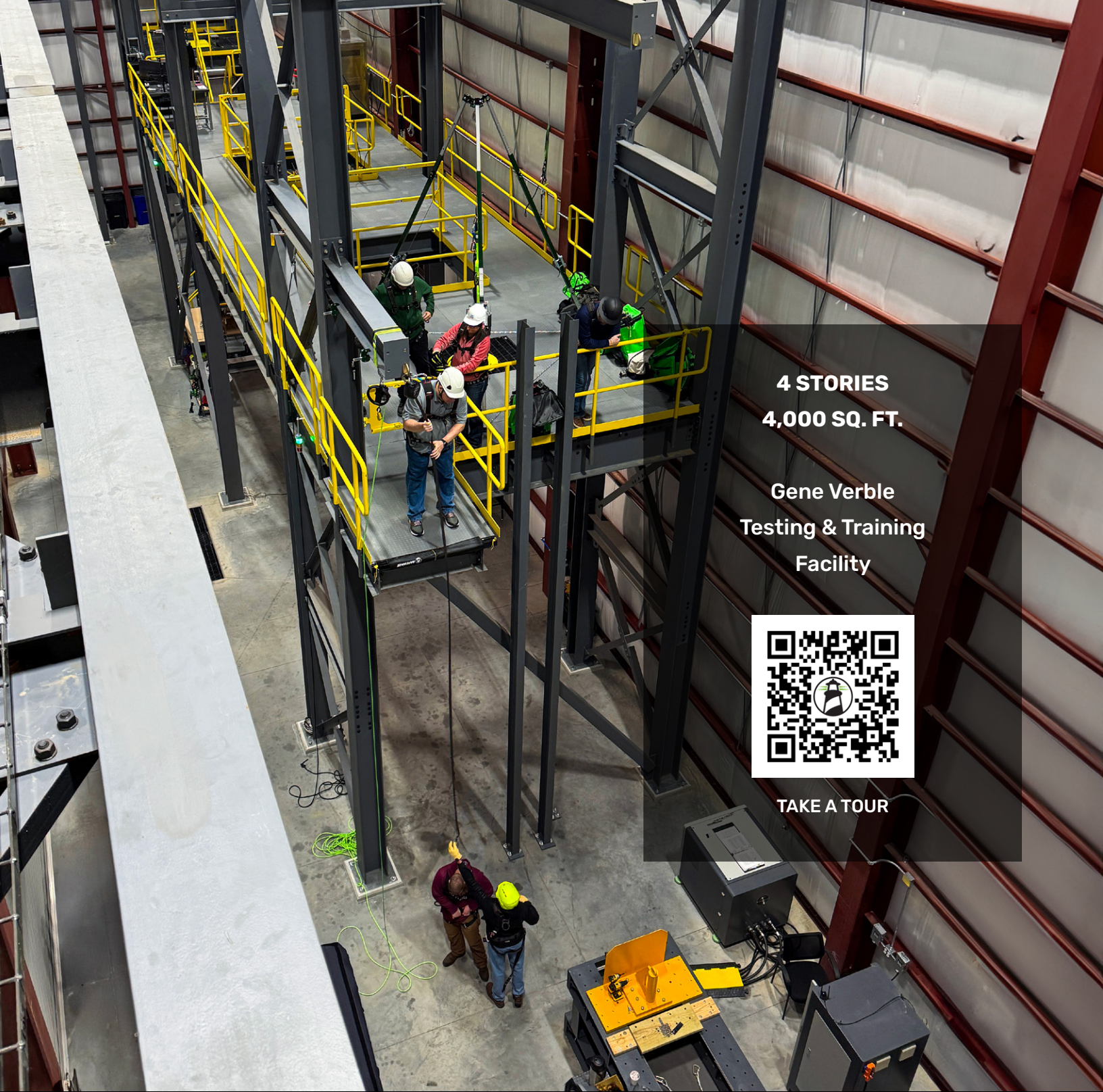

**4 STORIES
4,000 SQ. FT.**

**Gene Verble
Testing & Training
Facility**

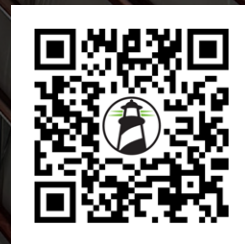

TAKE A TOUR

**WHAT'S
NEW AT
SAFEWAZE**

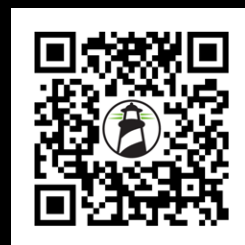

**WE
PROTECT
THE LIVES
AND
LIVELIHOODS
OF
WORKERS
AT HEIGHT**



SAFEWAZE

“

I rely on Safewaze fall protection for myself and choose to provide it for my team whenever possible. Their products offer exceptional comfort, are impressively lightweight and maintain a strong sense of protection.

Neeley Pattillo

Safety Professional

”



SAFEWAZE

800-230-0319

INFO@SAFEWAZE.COM



225 Wilshire Ave SW
Concord NC 28025



U.S. MANUFACTURER

GET CONNECTED

