



SW901 Window Door Jamb Anchor



WARNING

This product is part of a personal fall arrest, work positioning, suspension or rescue system. The manufacturer's instructions must be provided to users of this equipment. The user must follow the manufacturer's instructions for each component of the system. The user must read and understand these instructions before using this equipment. Manufacturer's instructions must be followed for proper use and maintenance of this equipment. Alterations to this product, misuse of this product, or failure to follow instructions may result in serious injury or death.

IMPORTANT
Questions regarding the use, care, or suitability of this equipment for your application? Contact Safewaze.

IMPORTANT
Record identification information before using this product. Identification information may be found on the equipment label. This information should be recorded in the "Inspection Log" located at the back of this manual.

Meets ANSI Z359.18-2017 Type A / OSHA 1926.502, 1910.140, 1910.66
This manual is intended to meet the manufacturer's instructions as required by ANSI Z359 and should be used as part of an employee training program as required by OSHA.

User Information

Date of First Use: _____
Serial#: _____
Trainer: _____
User: _____

Do not throw away these instructions!

Read and understand these instructions before using equipment!

INTRODUCTION

Thank you for purchasing a Safewaze Anchorage Connector. This manual must be read and understood in its entirety, and used as part of an employee training program as required by OSHA or any applicable state agency. This manual and any other instructional material must be available to the user of the equipment. The user must understand how to safely and effectively use these anchors, and all fall protection equipment used in conjunction with the anchor.

APPLICABLE SAFETY STANDARDS

When used according to instructions, Safewaze Anchors meet all applicable ANSI Z359.18-2017 and OSHA regulations for fall protection. Applicable standards and regulations depend on the type of work being done, and may include state-specific regulations. Refer to local, state, and federal (OSHA) requirements for additional information concerning the governing of occupational safety regarding Personal Fall Arrest Systems (PFAS).

WORKER CLASSIFICATIONS

Understand the definitions of those who work in proximity of or may be exposed to fall hazards.

Qualified Person: "Qualified Person" means one who, by possession of a recognized degree, certificate, or professional standing, or who by extensive knowledge, training, and experience, has successfully demonstrated his ability to solve or resolve problems relating to the subject matter, the work, or the project.

Competent Person: "Competent Person" means one who is capable of identifying existing and predictable hazards in the surroundings or working conditions which are unsanitary, hazardous, or dangerous to employees, and who has authorization to take prompt corrective measures to eliminate them.

Authorized Person: "Authorized Person" means a person approved or assigned by the employer to perform a specific type of duty or duties or to be at a specific location or locations at the job site.

It is the responsibility of a Qualified or Competent person to supervise the job site and ensure safety regulations are complied with.

PRODUCT SPECIFIC APPLICATIONS

Purpose: Safewaze Anchors are designed to be used as part of a Personal Fall Arrest System (PFAS).

- A competent person shall train users on this equipment in accordance with OSHA and ANSI.
- Never exceed a free fall distance of 6 ft. A free fall of more than 6 ft could cause excessive arrest forces that could result in serious injury or death.
- Safewaze Anchors have a maximum capacity of ANSI 310 lbs / OSHA 420 lbs including any tools, clothing, accessories, etc..., unless otherwise rated by Safewaze.
- Structures for attachment of Safewaze Anchors shall support a minimum 5,000 lbs or be designed with a safety factor of two by a Qualified Person.
- All Safewaze anchors must IMMEDIATELY be removed from service if subjected to fall arrest forces.
- Safewaze anchors shall be inspected by the end user prior to each usage and by a Competent Person other than the user at least annually. These inspections shall be documented.

LIMITATIONS

Fall Clearance: There must be sufficient clearance below the anchorage connector to arrest a fall before the user strikes the ground or an obstruction. When calculating fall clearance, account for a MINIMUM 2' safety factor, deceleration distance, user height, length of lanyard/SRL, and all other applicable factors. (See Figure 1)

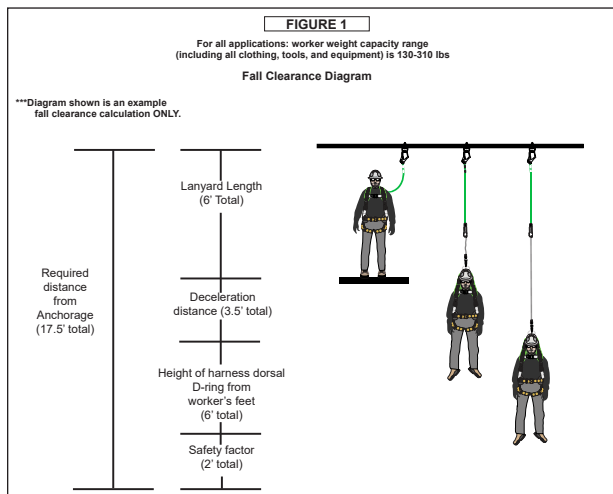

Swing Falls: Prior to installation or use, make considerations for eliminating or minimizing all swing fall hazards. Swing falls occur when the anchor is not directly above the location where a fall occurs. Always work as close to in line with the anchor point as possible. Swing falls significantly increase the likelihood of serious injury or death in the event of a fall. (See Figure 2)

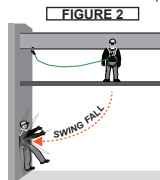

COMPATIBILITY OF CONNECTORS

Connectors are compatible with connecting elements when they have been designed to work together in such a way that their sizes and shapes do not cause their gate mechanisms to inadvertently open regardless of how they become oriented. Connectors (hooks, carabiners, and D-rings) must be capable of supporting at least 5,000 lbs. (22.2 kN). Connectors must be compatible with the anchorage or other system components (see Figure 4). **Do not use equipment that is not compatible.** Non-compatible connectors may unintentionally disengage (see Figure 3). Connectors must be compatible in size, shape, and strength. Self-locking snap hooks and carabiners are required by ANSI Z359 and OSHA guidelines. Contact Safewaze if you have any questions about compatibility.



NOTE: SOME SPECIALTY CONNECTORS HAVE ADDITIONAL REQUIREMENTS. CONTACT SAFEWAZE WITH QUESTIONS.

FIGURE 3 - UNINTENTIONAL DISENGAGEMENT

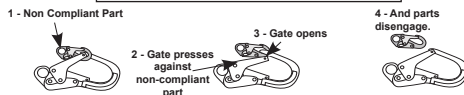

Using a connector that is undersized or irregular in shape (1) to connect a snap hook or carabiner could allow the connector to force open the gate of the snap hook or carabiner. When force is applied, the gate of the hook or carabiner presses against the non-compliant part (2) and forces open the gate (3). This allows the snap hook or carabiner to disengage (4) from the connection point.

MAKING CONNECTIONS

Snap hooks and carabiners used with this equipment must be double locking and/or twist lock. Ensure all connections are compatible in size, shape and strength. Do not use equipment that is not compatible. Ensure all connectors are fully closed and locked.

Safewaze connectors (snap hooks and carabiners) are designed to be used only as specified in each product's user's instructions. See figure 4 for examples of inappropriate connections. Do not connect snap hooks and carabiners:

- To a D-ring to which another connector is attached.
- In a manner that would result in a load on the gate (with the exception of tie back hooks). **NOTE:** Large snap hooks must not be connected to objects which will result in a load on the gate if the hook twists or rotates. Snap hooks marked with ANSI Z359.12 and are equipped with a 3,600 lb (16 kN) gate. Check the marking on your snap hook to verify its compatibility.



NOTE: Large throat snap hooks must not be connected to standard size D-rings or similar objects which will result in a load on the gate if the hook or D-ring twists or rotates, unless the snap hook complies with ANSI Z359.12 and is equipped with a 3,600 lb (16 kN) gate. Check the marking on your snap hook to verify that it is appropriate for your application.

- In a false engagement, where features that protrude from the snap hook or carabiner catch on the anchor, and without visual confirmation seems to be fully engaged to the anchor point.
- To each other.
- By wrapping the web lifeline around an anchor and securing to lifeline except as allowed for Tie Back models.
- To any object which is shaped or sized in a way that the snap hook or carabiner will not close and lock, or that roll-out could occur.
- In a manner that does not allow the connector to align properly while under load.

FIGURE 4 - INAPPROPRIATE CONNECTIONS

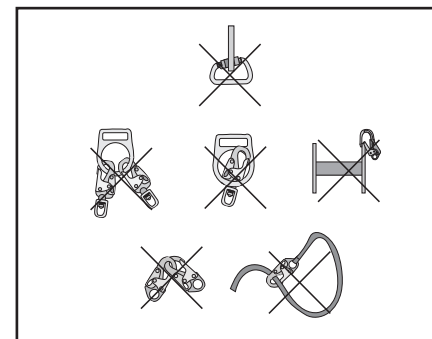

SPECIFIC ANCHOR APPLICATIONS



Personal Fall Arrest: Safewaze Anchors are designed as an anchor point to support a maximum of 1 Personal Fall Arrest System (PFAS) when utilized for fall protection applications. The structure to which the anchor is attached must withstand loads applied in the directions permitted by the system of at least 5,000 lbs. Maximum allowable free fall is 6'.



Restraint: Safewaze Anchors are authorized for use in Restraint applications. The structure to which the anchor is attached must withstand loads applied in the directions permitted by the system of at least 1,000 lbs. NO free fall is permitted. Restraint systems may only be used on surfaces with slopes up to 4 / 12 (vertical / horizontal). For Restraint applications, the allowable attachment points to harness are Dorsal D-ring, Chest D-ring, Side D-rings, and Shoulder D-rings.



Work Positioning: Safewaze Anchors are authorized for use in Work Positioning applications. Work Positioning allows a worker to be supported during suspension while freeing both hands to conduct work operations. The structure to which the Anchor is attached must withstand loads applied in the directions permitted by the system of at least 3,000 lbs. Maximum allowable free fall is 2'. For positioning applications, the allowable attachment points to harness are the Side D-rings.



Rescue/Confined Space: Safewaze Anchors are authorized for use in Rescue/Confined Space applications. Rescue systems are utilized to safely recover a worker from a confined location or after exposure to a fall. Composition of rescue systems can vary based upon the type of rescue involved. The structure to which the Anchor is attached must withstand loads applied in the directions permitted by the system of at least 3,000 lbs. NO free fall is permitted. For rescue applications, the allowable attachment points to harness are Dorsal D-ring, Chest D-ring and Shoulder D-rings.

All above referenced applications have a worker weight capacity range of ANSI 310 lbs / OSHA Up to 420 lbs (including all clothing, tools, and equipment).



SW900 ANCHOR COMPONENTS

FIGURE 5 - ANCHOR COMPONENTS

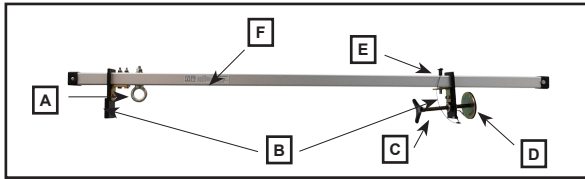

Anchor Components	
A	Fall Protection Connection Point
B	Jamming Frames
C	Set Bolt
D	Padded Brace Plate
E	Detent Locking Pin
F	Labeling

INSTALLATION

- The SW901 is designed for window and door openings. It installs into window/door jamb openings of 23.2" up to 49.2"
- The work location should be free of debris, and other materials or equipment that could interfere with the proper installation or operation of this equipment.
- Inspect the structure to which the anchor will be attached. User should inspect for the following hazards including, but not limited to: Damage to window/door frame, deterioration of the materials used in construction of the window/door jamb, rot, or decay. A Qualified Person must determine the suitability of the window/door jamb for installation and use of the SW901.
- Remove the detent pin and adjust the width of the SW901 until the jamming frames are in place in the interior of the window/door jamb (See Figure 6, Dwg. 1)
- Re-install the detent pin into the nearest pre-drilled hole in the anchor body. Turn the set bolt in a clockwise direction until the padded brace plate is snug against the window/door jamb structure. (See Figure 6, Dwg 2). Do not over-tighten as this may cause damage to the window/door jamb structure.
- The SW901 is now ready for use as part of a complete Personal Fall Arrest System (See Figure 6, Dwg. 4).

FIGURE 6 - INSTALLATION

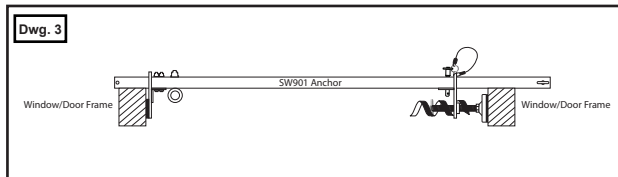
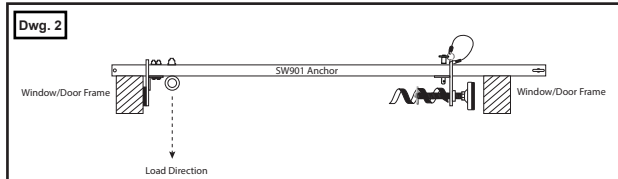
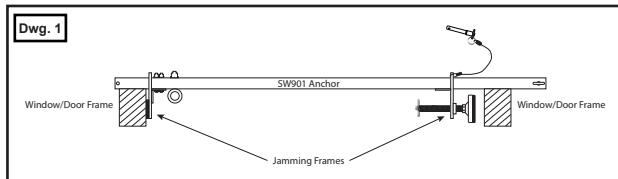

Dwg. 4

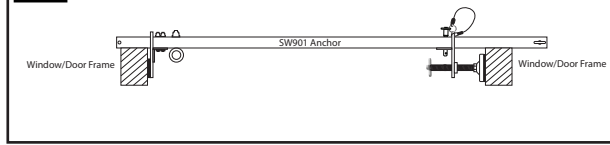
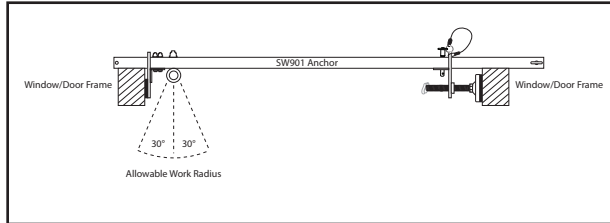

FIGURE 7 - ALLOWABLE WORK RADIUS



WARNING

- Users should consult with their doctor to verify ability to safely absorb the forces of a fall arrest event. Fitness level, age, and other health conditions can greatly affect an individual's ability to withstand fall arrest forces. Women who are pregnant, individuals considered minors must not use any Safewaze equipment.
- Never alter any part of an anchor or add/remove components. Safewaze shall not be held responsible for injury or death due to tampering.
- Anchors that are exposed to fall arrest forces MUST be IMMEDIATELY removed from service and destroyed.
- Failure to follow these instructions and warnings could result in serious injury or death in the event of a fall.
- A preplanned rescue procedure in the event of a fall is required. The rescue plan must be specific to the project. The rescue plan must allow for employees to rescue themselves, or to be promptly rescued by alternative means.
- Harnesses or connectors selected for use with any Safewaze anchor must be compatible in size and configuration. User must ensure compatibility of snap hooks, carabiners and other connectors. Any connection which could allow disengagement must be eliminated. Snap hooks and carabiners must be self locking and self closing and must never be hooked to each other.
- A Competent Person must conduct an analysis of the workplace and anticipate where workers will be conducting their duties, the route they will take to reach their work, and the existing and potential fall hazards they may be exposed to. The Competent Person must choose the fall protection equipment to be utilized.
- Do not misuse equipment.
- Equipment designated for fall protection must never be used to lift, hang, support or hoist tools or equipment unless specifically certified for such use.

INSPECTION

- Safewaze Anchors shall be inspected prior to each use by the user, and at least annually by a Competent Person other than the user. Annual inspections shall be documented. Severity of conditions during use may necessitate increased frequency of documented inspections.

- Anchors that fail inspection MUST be removed from service.

- Prior to each use, inspect the anchor for deficiencies or damage, including, but not limited to, sharp edges, rough edges, deformations, corrosion, pits, burrs, chemical exposure, extreme heat exposure, kinked, bird nested, or otherwise damaged cable, and damaged, missing or illegible labels. If any deficiencies or defects are found, the anchor must IMMEDIATELY be removed from service.

- The anchor must be inspected at least annually by a Competent Person other than the user. Competent person inspections must be recorded in the inspection log included in this manual and on the inspection grid label on the anchor.

WARRANTY

Safewaze warrants its products are free from defects in materials and construction under normal use and service. Liability is not accepted for abuse, modification, improper use, destructive activity and contaminated exposure.

MAINTENANCE & STORAGE

Anchor can be cleaned with water and mild soap if necessary. User should remove all dirt, possible corrosives, and contaminants from the anchor prior to, and after each use. Never use any type of corrosive substance to clean the anchor.

Excess water should be blown out with compressed air. Hardware can be wiped off with a clean, dry cloth.

When not in use, store the anchor in a cool dry area where it will not be exposed to extreme light, extreme heat, excessive moisture, or possibly corrosive chemicals or materials.

LABELS

	Product: Door Anchor Part No.: SW901 Stock No.: SW90X Mfg. : Kwik Size No.: SW90X PE: (800) 230-0319 www.safewaze.com	SPECIFICATIONS: Capacity: 17,000 lbs (7.7 kN) Minimum Working Load (MSL): 5,667 lbs (25.5 kN) Material: A307 Stainless Steel Finish: Galvanized Steel Weights and dimensions subject to change without notice.	INSPECTION: Inspect anchor before each use. Inspect regularly, anchor should be inspected at a frequency determined by the user, but not less than annually.	USE: This anchor should be used in conjunction with a fall protection system. Do not use this anchor as a support or hoist point. Do not use this anchor to support any other equipment.	WARNING: READ CAREFULLY BEFORE USING: This anchor is designed for use in window/door jamb openings. It is not to be used in any other application.
	ANS Z359.18-2017 TYPE A OSHA 1910.126, 1926.502				



INSPECTION LOG

Date	Inspection Items Noted	Corrective Action	Initials

